

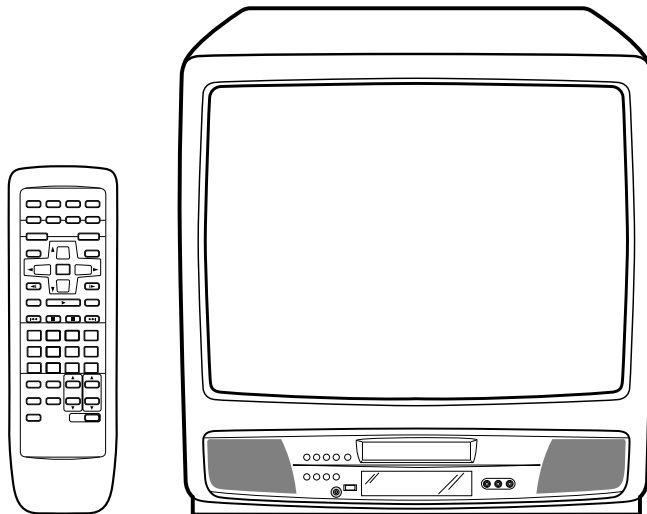

COMBINATION 25" COLOR TELEVISION AND DVD/CD PLAYER

Owner's Manual

MVD2256



ATTENTION

For your protection in the event of theft or loss of this product, please fill in the information listed below which is for your own personal records.

Date of Purchase : _____

Serial No. : _____



Place of Purchase : _____

TV/CATV MODE SELECTION

When shipped from the factory, the TV/CATV menu option is set to the "CATV"(Cable Television) mode.

If not using CATV, set this menu option to the "TV" position.

Before operating the unit, please read this manual thoroughly.

	CAUTION RISK OF ELECTRIC SHOCK DO NOT OPEN	
<p>CAUTION: TO REDUCE THE RISK OF ELECTRIC SHOCK, DO NOT REMOVE COVER (OR BACK). NO USER-SERVICEABLE PARTS INSIDE. REFER SERVICING TO QUALIFIED SERVICE PERSONNEL.</p>		



The lightning flash with arrowhead symbol within an equilateral triangle is intended to alert the user to the presence of uninsulated dangerous voltage within the product's enclosure that may be of sufficient magnitude to constitute a risk of electric shock to persons.



The exclamation point within an equilateral triangle is intended to alert the user to the presence of important operating and maintenance (servicing) instructions in the literature accompanying the appliance.

WARNING: TO PREVENT FIRE OR SHOCK HAZARD. DO NOT EXPOSE THIS APPLIANCE TO RAIN OR MOISTURE.

WARNING: This equipment has been tested and found to comply with the limits for a Class B digital device, pursuant to Part 15 of the FCC Rules. These limits are designed to provide reasonable protection against harmful interference in a residential installation. This equipment generates, uses, and can radiate radio frequency energy and, if not installed and used in accordance with the instructions, may cause harmful interference to radio communications. However, there is no guarantee that interference will not occur in a particular installation. If this equipment does cause harmful interference to radio or television reception, which can be determined by turning the equipment off and on, the user is encouraged to try correcting the interference by one or more of the following measures:

- Reorient or relocate the receiving antenna.
- Increase the separation between the equipment and receiver.
- Connect the equipment into an outlet on a circuit different from that to which the receiver is connected.
- Consult the dealer or an experienced radio/TV technician for help.

CAUTION: Changes or modifications not expressly approved by the party responsible for compliance with the FCC Rules could void the user's authority to operate this equipment.

CAUTION:
THIS DIGITAL VIDEO PLAYER EMPLOYS A LASER SYSTEM.

TO ENSURE PROPER USE OF THIS PRODUCT, PLEASE READ THIS OWNER'S MANUAL CAREFULLY AND RETAIN FOR FUTURE REFERENCE. SHOULD THE UNIT REQUIRE MAINTENANCE, CONTACT AN AUTHORIZED SERVICE LOCATION-SEE SERVICE PROCEDURE.

USE OF CONTROLS, ADJUSTMENTS OR THE PERFORMANCE OF PROCEDURES OTHER THAN THOSE SPECIFIED HEREIN MAY RESULT IN HAZARDOUS RADIATION EXPOSURE.

TO PREVENT DIRECT EXPOSURE TO LASER BEAM, DO NOT TRY TO OPEN THE ENCLOSURE. VISIBLE LASER RADIATION MAY BE PRESENT WHEN THE ENCLOSURE IS OPENED. DO NOT STARE INTO BEAM.

Location of the required Marking

The rating sheet and the safety caution are on the rear of the unit.

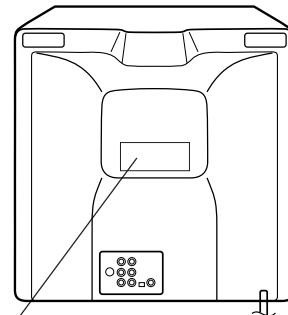

CERTIFICATION: COMPLIES WITH
FDA RADIATION PERFORMANCE
STANDARDS, 21 CFR SUBCHAPTER J.

IMPORTANT SAFEGUARDS

1. READ INSTRUCTIONS

All the safety and operating instructions should be read before the unit is operated.

2. RETAIN INSTRUCTIONS

The safety and operating instructions should be retained for future reference.

3. HEED WARNINGS

All warnings on the unit and in the operating instructions should be adhered to.

4. FOLLOW INSTRUCTIONS

All operating and use instructions should be followed.

5. CLEANING

Unplug this unit from the wall outlet before cleaning. Do not use liquid cleaners or aerosol cleaners. Use a damp cloth for cleaning.

6. ATTACHMENTS

Do not use attachments not recommended by the unit's manufacturer as they may cause hazards.

7. WATER AND MOISTURE

Do not use this unit near water. For example, near a bathtub, washbowl, kitchen sink, or laundry tub, in a wet basement, or near a swimming pool.

8. ACCESSORIES

Do not place this unit on an unstable cart, stand, tripod, bracket, or table. The unit may fall, causing serious injury, and serious damage to the unit. Use only with a cart, stand, tripod, bracket, or table recommended by the manufacturer.

- 8A. An appliance and cart combination should be moved with care. Quick stops, excessive force, and uneven surfaces may cause the appliance and cart combination to overturn.

PORTABLE CART WARNING
(symbol provided by RETAC)



S3126A

9. VENTILATION

Slots and openings in the cabinet and in the back or bottom are provided for ventilation, to ensure reliable operation of the unit, and to protect it from overheating. These openings must not be blocked or covered.

The openings should never be blocked by placing the unit on a bed, sofa, rug, or other similar surface. This unit should never be placed near or over a radiator or heat source. This unit should not be placed in a built-in installation such as a bookcase or rack unless proper ventilation is provided or the manufacturer's instructions have been adhered to.

10. POWER SOURCES

This unit should be operated only from the type of power source indicated on the rating plate. If you are not sure of the type of power supply to your home, consult your appliance dealer or local power company. For units intended to operate from battery power, or other sources, refer to the operating instructions.

11. GROUNDING OR POLARIZATION

This unit is equipped with a polarized alternating-current line plug (a plug having one blade wider than the other). This plug will fit into the power outlet only one way. This is a safety feature. If you are unable to insert the plug fully into the outlet, try reversing the plug. If the plug should still fail to fit, contact your electrician to replace your obsolete outlet. Do not defeat the safety purpose of the polarized plug. If your unit is equipped with a 3-wire grounding-type plug, a plug having a third (grounding) pin, this plug will only fit into a grounding-type power outlet. This too, is a safety feature. If you are unable to insert the plug into the outlet, contact your electrician to replace your obsolete outlet. Do not defeat the safety purpose of the grounding-type plug.

12. POWER-CORD PROTECTION

Power-supply cords should be routed so that they are not likely to be walked on or pinched by items placed upon or against them, paying particular attention to cords at plugs, convenience receptacles, and the point where they exit from the appliance.

13. LIGHTNING

To protect your unit from a lightning storm, or when it is left unattended and unused for long periods of time, unplug it from the wall outlet and disconnect the antenna or cable system. This will prevent damage to the unit due to lightning and power line surges.

14. POWER LINES

An outside antenna system should not be located in the vicinity of overhead power lines or other electric light or power circuits, or where it can fall into such power lines or circuits. When installing an outside antenna system, extreme care should be taken to keep from touching such power lines or circuits, as contact with them might be fatal.

IMPORTANT SAFEGUARDS

(Continued)

15. OVERLOADING

Do not overload wall outlets and extension cords, as this can result in a risk of fire or electric shock.

16. OBJECT AND LIQUID ENTRY

Do not push objects through any openings in this unit, as they may touch dangerous voltage points or short out parts that could result in fire or electric shock. Never spill or spray any type of liquid into the unit.

17. OUTDOOR ANTENNA GROUNDING

If an outside antenna or cable system is connected to the unit, be sure the antenna or cable system is grounded so as to provide some protection against voltage surges and built-up static charges. Section 810 of the National Electrical Code, ANSI/NFPA 70, provides information with respect to proper grounding of the mast and supporting structure, grounding of the lead-in wire to an antenna discharge unit, size of grounding conductors, location of antenna discharge unit, connection to grounding electrodes, and requirements for the grounding electrode.

18. SERVICING

Do not attempt to service this unit yourself as opening or removing covers may expose you to dangerous voltage or other hazards. Refer all servicing to qualified service personnel.

19. DAMAGE REQUIRING SERVICE

Unplug this unit from the wall outlet and refer servicing to qualified service personnel under the following conditions:

- a. When the power-supply cord or plug is damaged.
- b. If liquid has been spilled, or objects have fallen into the unit.
- c. If the unit has been exposed to rain or water.
- d. If the unit does not operate normally by following the operating instructions. Adjust only those controls that are covered by the operating instructions, as an improper adjustment of other controls may result in damage and will often require extensive work by a qualified technician to restore the unit to its normal operation.
- e. If the unit has been dropped or the cabinet has been damaged.
- f. When the unit exhibits a distinct change in performance, this indicates a need for service.

20. REPLACEMENT PARTS

When replacement parts are required, be sure the service technician uses replacement parts specified by the manufacturer or those that have the same characteristics as the original parts.

Unauthorized substitutions may result in fire, electric shock or other hazards.

21. SAFETY CHECK

Upon completion of any service or repairs to this unit, ask the service technician to perform safety checks to determine that the unit is in proper operating condition.

22. WALL OR CEILING MOUNTING

The product should be mounted to a wall or ceiling only as recommended by the manufacturer.

23. HEAT

The product should be situated away from heat sources such as radiators, heat registers, stoves, or other products (including amplifiers) that produce heat.

24. DISC TRAY

Keep your fingers well clear of the disc tray as it is closing. It may cause serious personal injury.

25. CONNECTING

When you connect the product to other equipment, turn off the power and unplug all of the equipment from the wall outlet. Failure to do so may cause an electric shock and serious personal injury. Read the owner's manual of the other equipment carefully and follow the instructions when making any connections.

26. SOUND VOLUME

Reduce the volume to the minimum level before you turn on the product. Otherwise, sudden high volume sound may cause hearing or speaker damage.

27. SOUND DISTORTION

Do not allow the product output distorted sound for a longtime. It may cause speaker overheating and fire.

28. HEADPHONES

When you use the headphones, keep the volume at a moderate level. If you use the headphones continuously with high volume sound, it may cause hearing damage.

29. LASER BEAM

Do not look into the opening of the disc tray or ventilation opening of the product to see the source of the laser beam. It may cause sight damage.

30. DISC

Do not use a cracked, deformed, or repaired disc. These discs are easily broken and may cause serious personal injury and product malfunction.

31. NOTE TO CATV SYSTEM INSTALLER

This reminder is provided to call the CATV system installer's attention to Article 820-40 of the NEC that provides guidelines for proper grounding and, in particular, specifies that the cable ground shall be connected to the grounding system of the building, as close to the point of cable entry as practical.

EXAMPLE OF ANTENNA GROUNDING AS PER THE NATIONAL ELECTRICAL CODE

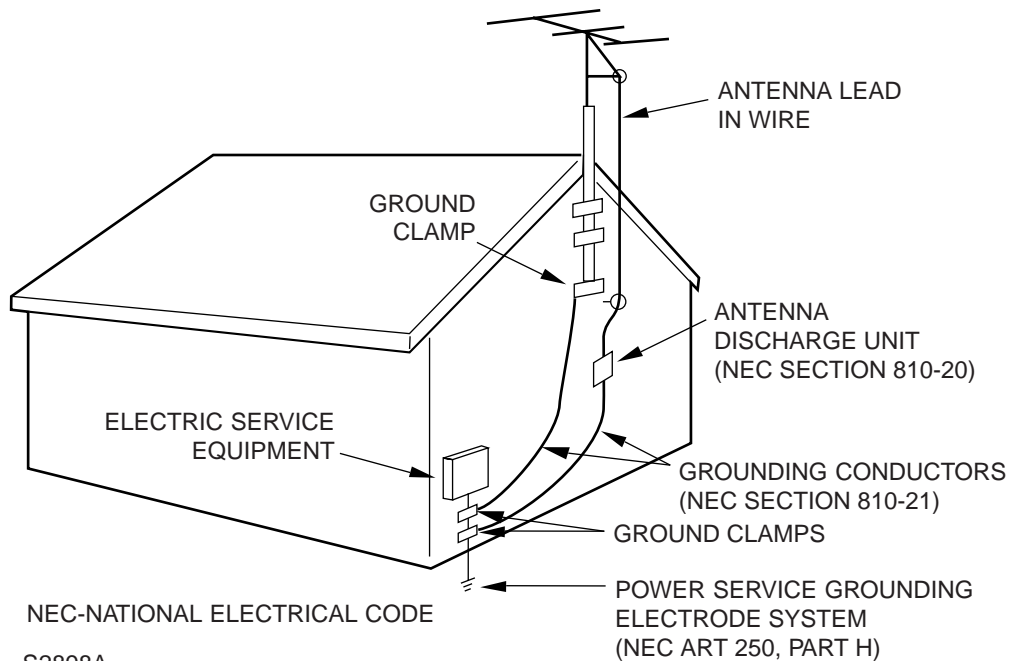

CONDENSATION

Moisture will form in the operating section of the player if the player is brought from cool surroundings into a warm room or if the temperature of the room rises suddenly. When this happens, player's performance will be impaired.

To prevent this, let the player stand in its new surroundings for about an hour before switching it on, or make sure that the room temperature rises gradually.

Condensation may also form during the summer if the player is exposed to the breeze from an air conditioner. In such cases, change the location of the player.

Features

Color TV With DVD/CD player

Unique space saving design combines a 25" color TV and a DVD/CD player.

The DVD disc has much more capacity, but is the same size as the audio CD disc. Picture/Audio quality of the DVD exceeds other software. Picture quality is higher than Super VHS. Audio quality is higher than audio CD. The DVD also has special options; audio language selection, subtitle language selection or multi-angle, etc.

The DVD PLAYER can play back audio CDs.

High Quality Picture

Horizontal Resolution

More than 500 lines. It exceeds Super VHS (400 lines) or Laser Disc (430 lines) in resolution.

Compatible with a wide range of DVD audio outputs

Optical Digital Audio Jack/Coaxial Digital Audio Jack

- When a component with a built-in Dolby Digital decoder is connected, Dolby Digital sound can produce the effect of being in a movie theater or a concert hall.
- Surround standard different from Dolby Digital. This format is already in use in many theaters. By connecting this unit to a DTS decoder or an AV amplifier with a built-in DTS decoder, the DTS audio of DVD discs recorded in this format can be enjoyed. However, audio will not be output from the analog audio output jacks.
- By connecting this unit to an AV amplifier with a built-in MPEG decoder, the MPEG audio of DVD discs recorded in this format can be enjoyed.
- The Linear PCM sound of a 48 kHz/16 bit through 96 kHz/20 bit exceeds audio CD sound.

Convenience Features

Direct selection of your desired scenes using Title/Chapter/Time/Track - You can play back from the desired scene.

Recalling Up to 3 Scenes (DVD only) - You can program up to 3 scenes in memory and recall the marked scenes.

Color Signal Conversion - The unit can play back NTSC or PAL discs. NTSC or PAL system TV allows watching both NTSC and PAL disc without changing the monitor.

Frame Advance - The **PAUSE/STILL** moves one frame at a time.

Slow Motion - The **SLOW** moves you back and forth through the program at back speed about 1/2X and forth speed about 1/4.

Repeat Playback - You can repeat chapter, track, title, sides or material between two selected points.

Program Playback (Audio CD) - You can play back tracks in programmed sequences.

4: 1 Zoom (DVD only) - You can zoom in the selected subject on the screen during playback.

Note: Make sure that discs are suitable for the following functions.

Multi-Language - Maximum 32 language subtitles and maximum 8 language soundtracks can be played back for movies or programmes.

Multi-Angle - Pictures of Sports or a Live Concert are recorded with many cameras. When you play such a disc, you can change the angles during playback.

Parental Control - You can limit the play back of scenes or sounds of adult DVD discs which have parental level.

Video Aspect Ratio - You can change the aspect ratio of the screen for your monitor.

TV Features

181 Channel Tuner - Receives standard VHF and UHF broadcast channels and up to 113 cable channels. The actual number of channels received depends upon channel reception in your area or your cable system.

Closed Caption Decoder With Full Text Mode - Displays text captions or full screen text on the screen for hearing impaired viewers.

Picture Adjustments Using The Remote Control - The On-Screen display allows precise remote control adjustment of BRIGHTNESS, CONTRAST, COLOR, TINT and SHARPNESS.

Programmable TV Sleep Timer - Operable from the remote control, the TV can be programmed up to 120 minutes to turn off automatically.

On-Screen 3 Language Display - You can select one of 3 languages, English, Spanish or French for on-screen programming.

V-Chip - The V-Chip function can rate a TV program or movie content. It allows you to set a restriction level.

This product incorporates copyright protection technology that is protected by method claims of certain U.S. patents and other intellectual property rights owned by Macrovision Corporation and other rights owners. Use of this copyright protection technology must be authorized by Macrovision Corporation, and is intended for home and other limited viewing uses only unless otherwise authorized by Macrovision Corporation. Reverse engineering or disassembly is prohibited.

Before using your unit

IMPORTANT SAFEGUARDS	2
Features	6
Contents	7
Parts and functions	8
Remote control	10
Power source	11
Antenna connections	12
Cable TV connections	13

TV operation

Setting the language	14
TV operation	15
Closed caption	17
To memorize channels	18
Setting the V-Chip	20
Picture control adjustment	23
Stereo and separate audio program (SAP)	24
Sound control adjustment	25

Playback operation

Disc	26
Setting setup language	27
Playback procedure	28
Special playback	29

Advanced Function

Zooming	30
Locating desired scene	30
Repeat playback	31
Program playback (Audio CD)	32
Marking desired scenes	33
Changing soundtrack language	34
Subtitles	35
Changing angles	36
Title selection	36
DVD menu	36

Additional Information

Rating level setting	37
To unlock the rating	38
Setting audio soundtrack language	39
Setting subtitle language	40
Setting the aspect ratio of TV screen	41
Setting on screen display	42
Setting menu language	43
Setting audio output	44
Language code list	45
Connection to other equipments	46
Problems and troubleshooting	48
Reception disturbances	50
Specifications	51

Parts and functions

Front

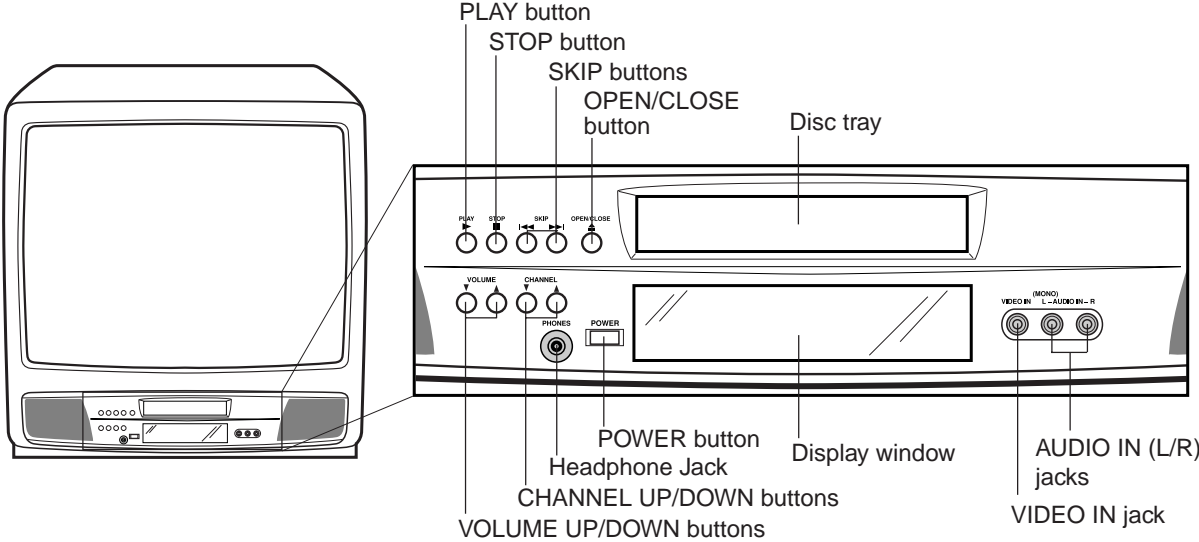

Rear

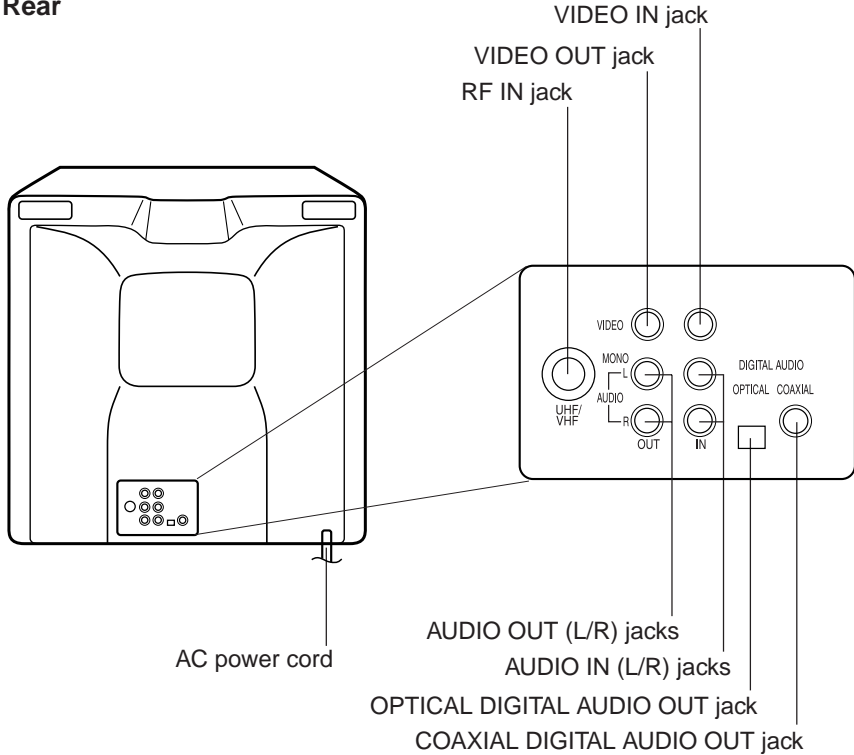

Parts and functions

Display window

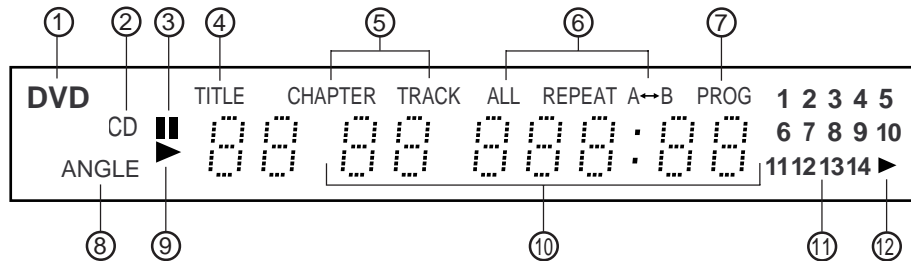

No.	Display	Descriptions
①	DVD	DVD disc is inserted.
②	CD	Audio CD is inserted.
③		Still (pause)
④	TITLE	Title number (DVD only)
⑤	CHAPTER	Chapter number (DVD only)
	TRACK	Track number (Audio CD)
⑥	ALL REPEAT	Repeat all of disc
	REPEAT	Repeat of title/chapter/track
	A↔B REPEAT	Repeat of two desired point
⑦	PROG	Program play (Audio CD)
⑧	ANGLE	Angle playback
⑨	▶	Playback
⑩	OPEN	The disc tray is open.
	CLOSE	The disc tray is being closed.
	NO DISC	No disc is loaded.
	NO PLAY	Playback is impossible.
	12:34	Playing time
	OFF	DVD power is being turned off.
⑪	12345.....	List of chapter number (DVD)
		List of track number (Audio CD)
⑫	▶	For a disc for containing 15 or more chapters/tracks

Note:

Depending on the DVD, the chapter number or time may not appear or you may not be able to change the front panel display.

Remote control

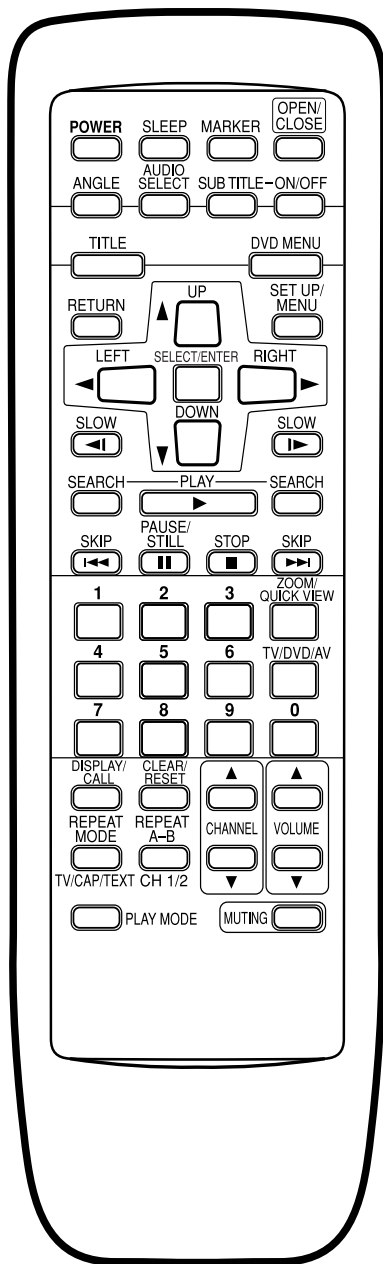

		Page
POWER	Power On/Off	14,15,27
SLEEP	Sleep timer	16
MARKER	Index	33
OPEN/CLOSE	Tray open or close	28
ANGLE	Change playback angle	36
AUDIO SELECT	Switch the sound of TV	24
SUB TITLE-ON/OFF	Subtitle	35
TITLE	Select title	36
DVD MENU		36
RETURN		37-44
SET UP/MENU	Call initial setup mode Display menu of TV	27,37-44 14,18-25
UP/DOWN/LEFT/ RIGHT	Cursor buttons	14,27,28,30 32-44
SELECT/ENTER	Select option in the menu Enter information in the menu	27,28 14,18-25
SLOW	Forward/Reverse- slow motion	29
SEARCH	Fast Forward/Review playback	29
PLAY	Playback	28,32,36
SKIP	Skip chapter to forward or reverse direction	29
PAUSE/STILL	Pause CD sound Still picture of DVD	29
STOP	Stop	28
0-9	Direct channel selection of TV Call a desired scene Enter a password	15,19 30 20,22,38
ZOOM/QUICK VIEW	Zoom Switch between present/last channel	30 16
TV/DVD/AV	Switch between TV/DVD/AV	27,47
DISPLAY/CALL	Call title, chapter and time Call channel no. on screen	30 16
CLEAR/RESET	Cancel index mark Reset information in the menu	33 20-23
REPEAT MODE	Repeat playback	31
TV/CAP/TEXT	Switch between TV/Caption/Text in Closed Caption mode	17
REPEAT A-B	Repeat playback between A and B	31
CH 1/2	Switch between channel 1 and 2 in Closed Caption mode	17
CHANNEL	Select channel of TV	16
VOLUME	Adjust volume of TV	15,16
PLAY MODE	Select playback mode	32
MUTING	Turn the sound on and off	16

Remote control

Inserting Batteries

1 Open the battery compartment cover.

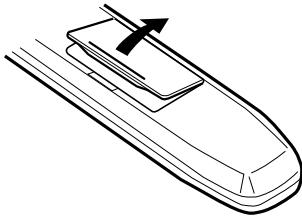

2 Insert two AA batteries as shown.

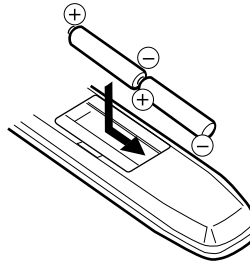

3 Replace the cover.

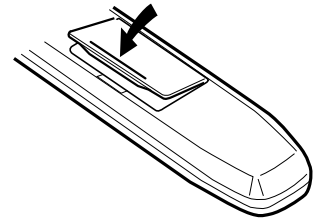

Operation

- Aim the remote control at the remote sensor and press control buttons to operate.
- Operate the remote control within 30° angle on either side of the remote sensor, up to a distance of Approx. 5 meters.

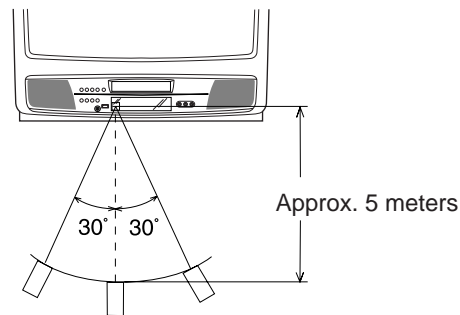

NOTE:

- Do not leave the remote control unit exposed to direct sunlight or in hot or humid places.
- The remote control unit uses infrared beams to transmit signals, so sunlight or fluorescent light on the remote sensor may shorten operating distance.
- Incorrect use of batteries may cause them to leak or burst. Read the battery warnings and use the batteries properly.
- Do not mix old and new batteries.
- Remove batteries if the remote control will not be operated for an extended period of time.

Power Source

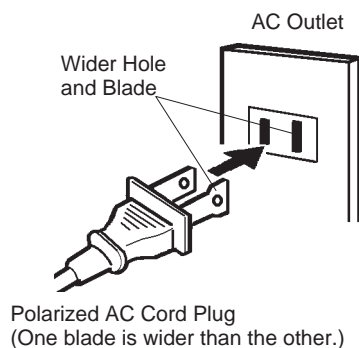

TO USE AC POWER SOURCE

Use the AC polarized line cord provided for operation on AC. Insert the AC cord plug into a standard 120V 60Hz polarized AC outlet.

NOTES:

- Never connect the AC line cord plug to other than the specified voltage (120V 60Hz). Use the attached power cord only.
- If the polarized AC cord does not fit into a non-polarized AC outlet, do not attempt to file or cut the blade. It is the user's responsibility to have an electrician replace the obsolete outlet.
- If you cause a static discharge when touching the unit, and the unit fails to function, simply unplug the unit, from the AC outlet, wait a few minutes, and plug it back in. The unit should return to normal operation.

Antenna connections

If you are using an indoor or outdoor antenna, follow the instructions below that correspond to your antenna system. If you are using a cable TV service (CATV), see page 13 for Cable TV connections.

Combination VHF/UHF Antenna (Single 75 ohm Cable or 300 ohm Twin-lead Wire)

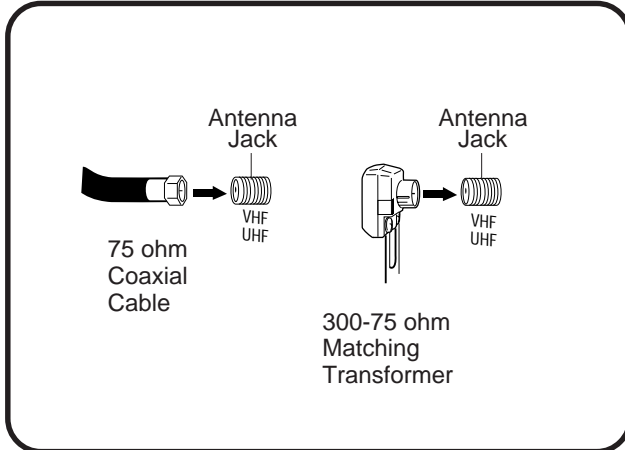

Connect the 75 ohm Cable from the Combination VHF/UHF Antenna to the Antenna Jack.

If your Combination VHF/UHF Antenna has a 300 ohm Twin-lead Wire, the use of the 300-75 ohm Matching Transformer may be necessary.

Combination VHF/UHF Antenna (Separate VHF and UHF 300 ohm Twin-lead Wires)

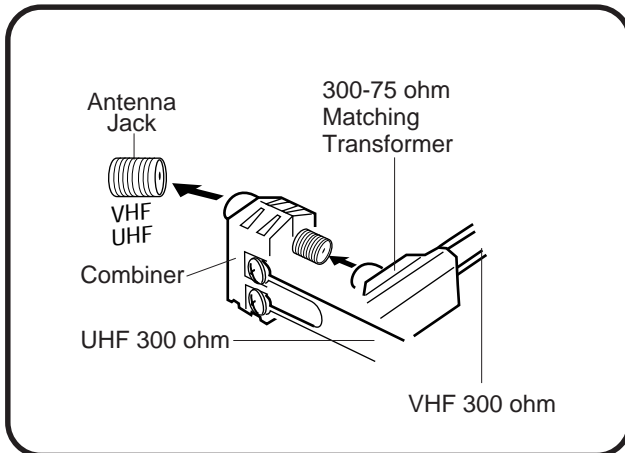

Connect the UHF 300 ohm Twin-lead Wire to the Combiner (not supplied). Connect the VHF 300 ohm Twin-lead Wire to the 300-75 ohm Matching Transformer. Attach the Transformer to the Combiner, then attach the Combiner to the Antenna Jack.

Separate VHF/UHF Antennas (75 ohm VHF Cable and 300 ohm UHF Twin-lead Wires)

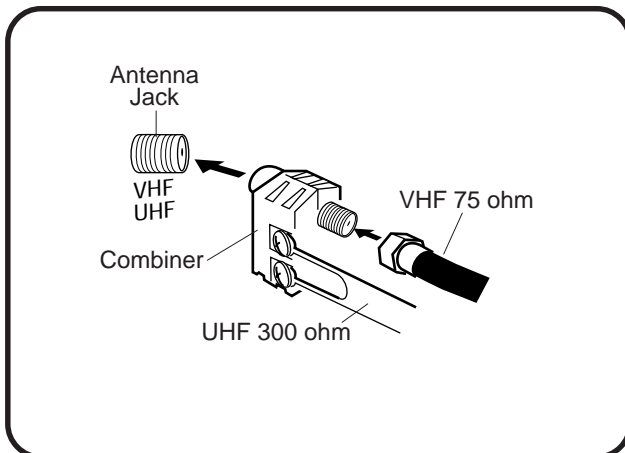

Connect the VHF 75 ohm cable and UHF 300 ohm Twin-lead Wire to the Combiner. Attach the Combiner to the Antenna Jack.

Cable TV connections

This TV/DVD has an extended tuning range and can tune most cable channels without using a Cable TV Converter box. Some cable companies offer “premium pay channels” in which the signal is scrambled. Descrambling these signals for normal viewing requires the use of a descrambler device which is generally provided by the cable company.

FOR SUBSCRIBERS TO BASIC CABLE TV SERVICE

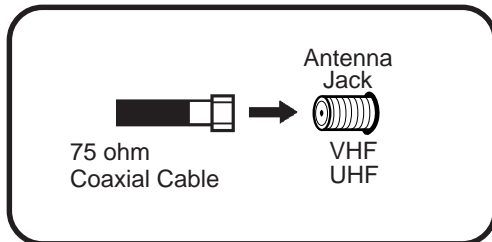

For basic cable service not requiring a Converter/Descrambler box, connect the CATV 75 ohm Coaxial Cable directly to the Antenna Jack on the back of the TV/DVD.

FOR SUBSCRIBERS TO SCRAMBLED CABLE TV SERVICE

If you subscribe to a cable TV service which requires the use of a Converter/Descrambler box, connect the incoming 75 ohm Coaxial Cable to the Converter/Descrambler box. Using another 75 ohm Coaxial Cable, connect the output jack of the Converter/Descrambler box to the Antenna Jack on the TV/DVD. Follow the connections shown below. Set the TV/DVD to the output channel of the Converter/Descrambler box (usually channel 3 or 4) and use the Converter/Descrambler box to select channels.

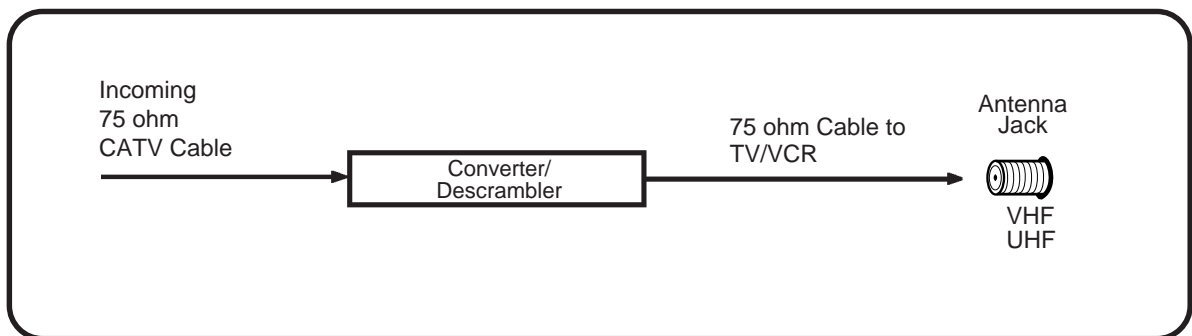

FOR SUBSCRIBERS TO UNSCRAMBLED BASIC CABLE TV SERVICE WITH SCRAMBLED PREMIUM CHANNELS

If you subscribe to a cable TV service in which basic channels are unscrambled and premium channels require the use of a Converter/Descrambler box, you may wish to use a signal Splitter and an A/B Switch box (available from the Cable company or an electronics supply store). Follow the connections shown below. With the switch in the “B” position, you can directly tune any nonscrambled channels on your TV/DVD. With the switch in the “A” position, tune your TV/DVD to the output of the Converter/Descrambler box (usually channel 3 or 4) and use the Converter/Descrambler box to tune scrambled channels.

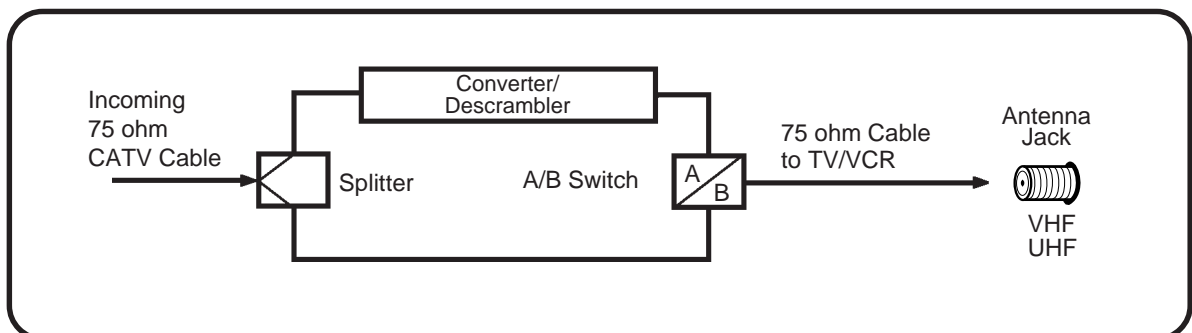

Setting the language

This TV can display the on screen language in English, Spanish or French. Language selection (step 4) will automatically appear on the screen when you press the MENU button initially. Select language to use the other menu options.

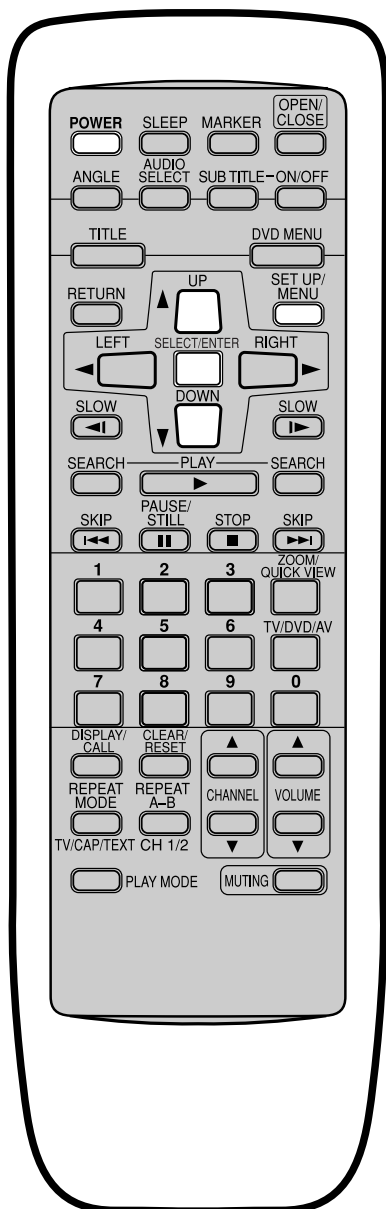

1 To turn on the TV/DVD, press **POWER**.

2 Press **MENU**. The TV menu screen will appear.

3 Press **UP** or **DOWN** to select the "LANGUAGE" option, then press **ENTER**.

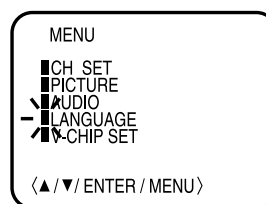

4 Press **UP** or **DOWN** to select the desired language: English (ENGLISH), Spanish (ESPAÑOL) or French (FRANCAIS), then press **ENTER**.



Press **MENU** until the MENU screen is cleared.

NOTE:

- If the unit does not operate properly, or No key operation (by the unit and/or the remote control): Static electricity, etc., may affect the player's operation. Disconnect the AC power cord once, then connect it again.
- The TV section has its own menu and also DVD section has its own menu (see page 27).

TV operation

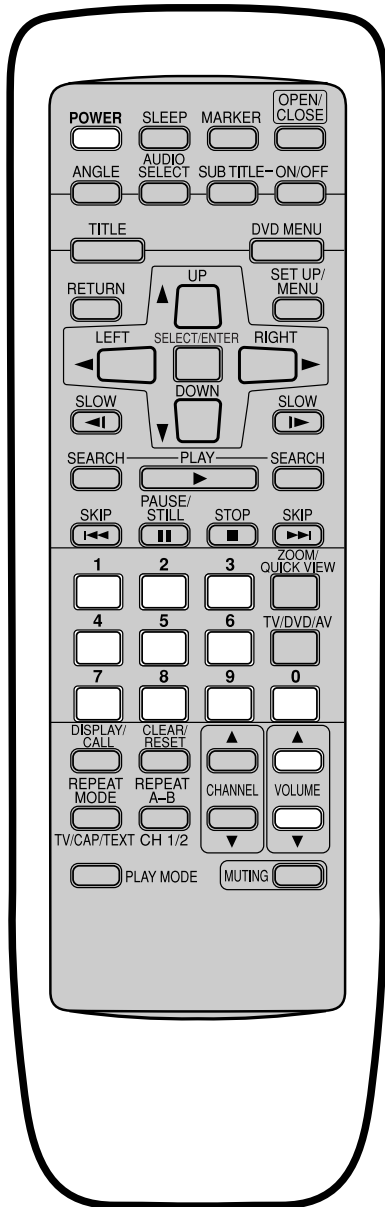

NOTES:

- If a channel with no broadcast is selected, the sound will automatically be muted.
- If a station being viewed stops broadcasting, the TV will automatically shut itself off after 15 minutes.

- 1 To turn on the TV/DVD, press **POWER**.
- 2 Adjust the volume level by pressing **VOLUME UP** or **DOWN**. The volume level will be indicated on the screen by green bars. As the volume level increases, so do the number of bars. If the volume decreases, the number of green bars also decreases.
- 3 Set the TV/CATV menu option to the appropriate position. (See page 18.)

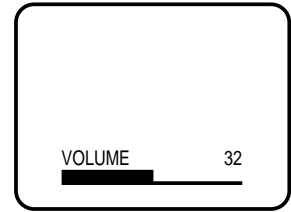

TV - VHF/UHF channels
CATV - CABLE TV channels

- 4 Press the Direct Channel selection buttons to select the channel.
TV Mode Direct Channel Selection
When the TV/CATV menu option is in the TV position, all channels can be instantly selected by using two buttons. (for example, to select channel 2, press "0", then "2". If you press only "2", channel selection will be delayed for a few seconds.) For channels 10 and above, press the 2 digits in order.

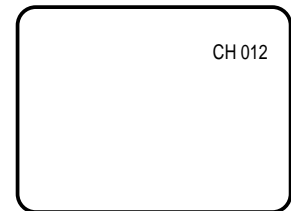

CATV Mode Direct Channel Selection

When the TV/CATV menu option is in the CATV position, channels can be selected as follows:

TO SELECT CATV CHANNELS:

- 1-9: Press "0" twice, then 1-9 as needed. Example, to select channel 2, press "002".
- 10-19: Press "0", then the remaining 2 digits. Example, to select channel 12, press "012".
- 20-99: Press the 2 digits in order. Example, to select channel 36, press "36".
- 100-125: Press the 3 digits in order. Example, to select channel 120, press "120".

NOTE FOR CHANNELS 1-19:

If only 1 or 2 buttons are pressed, the corresponding channel will be selected in 2 seconds.

TV	CATV
VHF 2-13	VHF 2-13
UHF 14-69	STD/HRC/IRC 14-36 (A) (W) 37-59 (AA) (WW) 60-85 (AAA) (ZZZ) 86-94 (86) (94) 95-99 (A-5) (A-1) 100-125 (100) (125) 01 (5A)

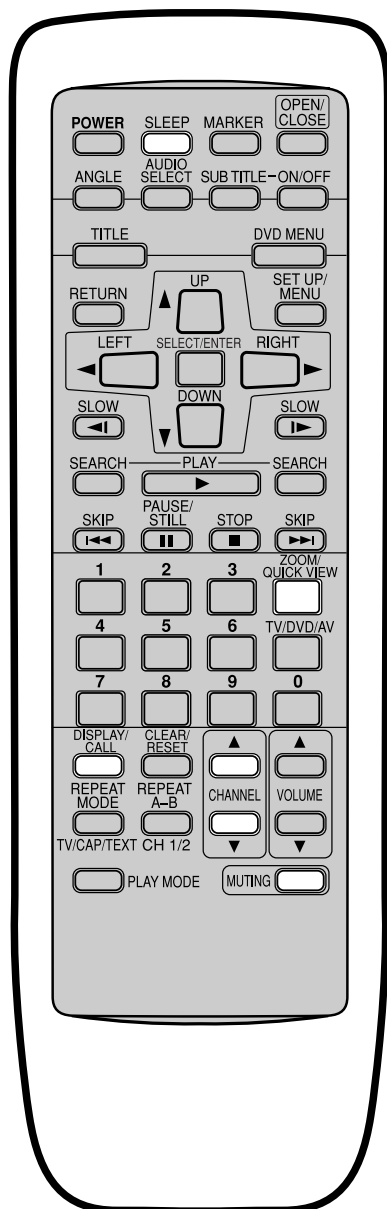

MUTING

Press **MUTING** to turn off the sound. The TV/DVD's sound will be silenced and "MUTING" will briefly appear on the screen. The sound can be turned back on by pressing **MUTING** again or one of the **VOLUME UP** and **DOWN**.

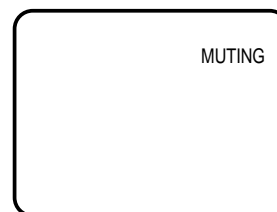

CHANNEL UP/DOWN

Press and release **CHANNEL UP** or **DOWN**. The channel automatically stops at the next channel set into memory. Press and hold the button down to change channels more quickly.

For proper operation, before selecting channels, they should be set into the memory.

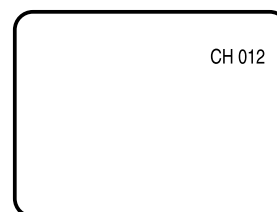

CALL

Press **CALL**. The channel number will be indicated. Press **CALL** again to disappear the call display.

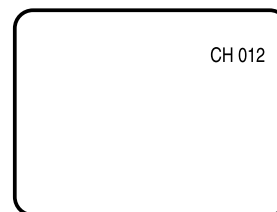

QUICK VIEW

This button allows you to go back to the last channel selected by pressing **QUICK VIEW**. Press **QUICK VIEW** again to return to the last channel you were watching.

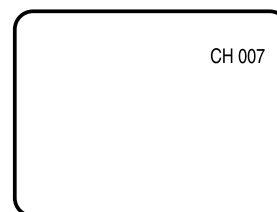

SLEEP

To set the TV/DVD to turn off after a preset amount of time, press **SLEEP** on the remote control. The clock will count down 10 minutes for each press of **SLEEP** (120, 110, ...10, 0). After the sleep time is programmed, the display will appear briefly every ten minutes to remind you that the sleep timer is operating. To confirm the sleep timer setting, press **SLEEP** and the remaining time will be momentarily displayed. To cancel the sleep timer, press **SLEEP** repeatedly until the display turns to 0.

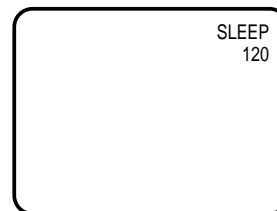

Closed caption

WHAT IS CLOSED CAPTIONING?

This television has the capability to decode and display Closed Captioned television programs. Closed Captioning will display text on the screen for hearing impaired viewers or it will translate and display text in another language.

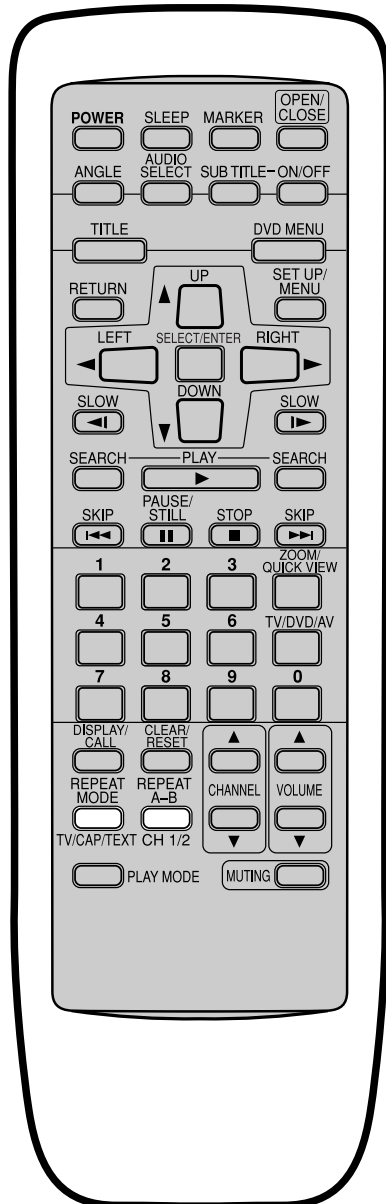

Captions: This Closed Caption Mode will display text on the screen in English or another language (depending on the setting of the Closed Captions **CH 1/2**).

Generally, Closed Captions in English are transmitted on Captions Channel 1 and Closed Captions in other languages are transmitted on Captions Channel 2.

Text: The Text Closed Caption Mode will usually fill the screen with a programming schedule or other information.

After selecting a Closed Caption Mode, it will stay in effect until it is changed, even if the channel is changed.

If the Captions signal is lost due to a commercial or a break in the signal, the Captions will reappear when the signal is received again. If the channels are changed, the Captions will be delayed approximately 10 seconds. The Captions will appear in places on the screen where they will least interfere with the picture, usually on the bottom of the screen. News programs will usually show three-line Closed Captions which scroll onto the screen.

Most other shows provide two or three lined Captions placed near the character who is speaking so the viewer can follow the dialogue. Words in italics or underlined describe titles, words in foreign languages or words requiring emphasis. Words that are sung usually appear enclosed by musical notes.

For television programs broadcasting with Closed Captions, look in your TV guide for the Closed Captions symbol (CC).

TO VIEW CLOSED CAPTIONS

Press **TV/CAP/TEXT** to switch between normal TV and the two closed caption modes (captions and full screen text). Closed captioning will display text on the screen for hearing impaired viewers.

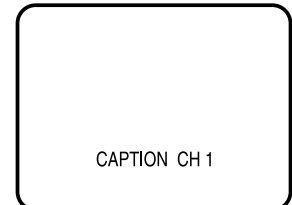

NOTES:

- When selecting Closed Captions, the captioning will be delayed approximately 10 seconds.
- If no caption signal is received, no captions will appear, but the television will remain in the Caption Mode.
- Misspellings or unusual characters may occasionally appear during Closed Captioning. This is normal with Closed Captioning, especially with live programs. This is because during live programs, captions are also entered live. These transmissions do not allow time for editing.
- When Captions are being displayed, on-screen displays, such as volume and mute may not be seen or may interfere with Closed Captions.
- Some cable systems and copy protection systems may interfere with the Closed Captioned signal.
- If using an indoor antenna or if TV reception is very poor, the Closed Caption Decoder may not appear or may appear with strange characters or misspelled words. In this case, adjust the antenna for better reception or use an outdoor antenna.

To memorize channels

This TV/DVD is equipped with a channel memory feature which allows channels to skip up or down to the next channel set into memory, skipping over unwanted channels. Before selecting channels, they must be programmed into the TV/DVD's memory. In addition to normal VHF and UHF channels, this TV/DVD can receive up to 113 Cable TV channels. To use this TV/DVD with an antenna, set the TV/CATV menu option to the TV mode. When shipped from the factory, this menu option is in the CATV mode.

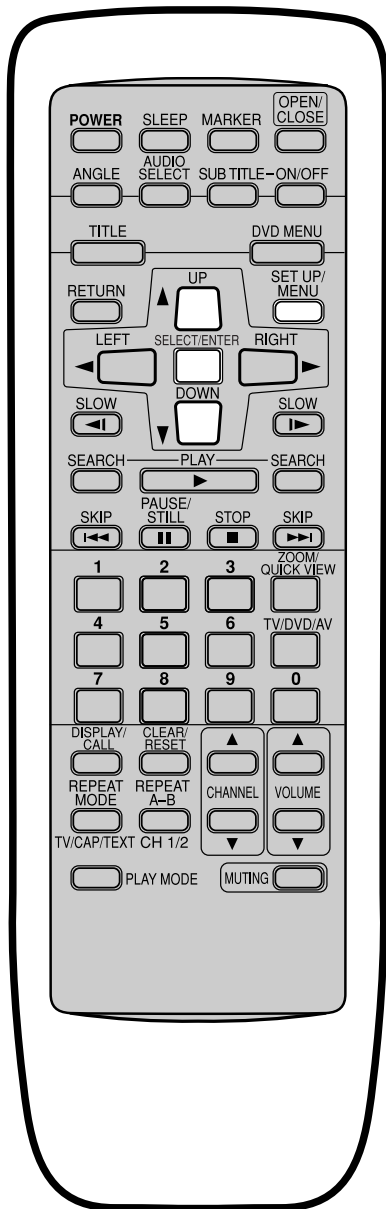

TV/CATV SELECTION

- 1 Press **MENU**.
- 2 Press **UP** or **DOWN** to select the "CH SET" option, then press **ENTER**.

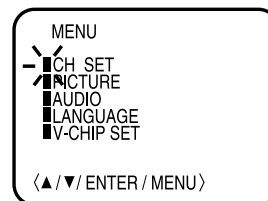

- 3 Press **UP** or **DOWN** to select the "TV/CATV".

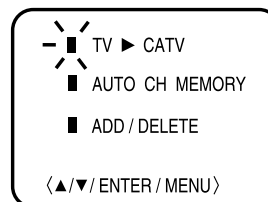

- 4 Press **ENTER** to select the TV or CATV mode. The arrow indicates the selected mode.

TV - VHF/UHF channels
CATV - CABLE TV channels

- 5 Press **MENU** until the MENU screen is cleared.

CATV CHART

The chart below is typical of many cable system channel allocations.

Number on this TV														14	15	16	17	18	19	20	21	22
Corresponding CATV channel														A	B	C	D	E	F	G	H	I
23	24	25	26	27	28	29	30	31	32	33	34	35	36	37	38	39	40					
J	K	L	M	N	O	P	Q	R	S	T	U	V	W	AA	BB	CC	DD					
41	42	43	44	45	46	47	48	49	50	51	52	53	54	55	56	57	58					
EE	FF	GG	HH	II	JJ	KK	LL	MM	NN	OO	PP	QQ	RR	SS	TT	UU	VV					
59	60	61	62	63	64	65	66	67	68	69	70	71	72	73	74	75	76					
WW	AAA	BBB	CCC	DDD	EEE	FFF	GGG	HHH	III	JJJ	KKK	LLL	MMM	NNN	OOO	PPP	QQQ					
77	78	79	80	81	82	83	84	85	86	87	88	89	90	91	92	93	94					
RRR	SSS	TTT	UUU	VVV	WWW	XXX	YYY	ZZZ	86	87	88	89	90	91	92	93	94					
95	96	97	98	99	100	101	102	103	104	105	106	107	108	109	110	111	112					
A-5	A-4	A-3	A-2	A-1	100	101	102	103	104	105	106	107	108	109	110	111	112					
113	114	115	116	117	118	119	120	121	122	123	124	125	01									
113	114	115	116	117	118	119	120	121	122	123	124	125	5A									

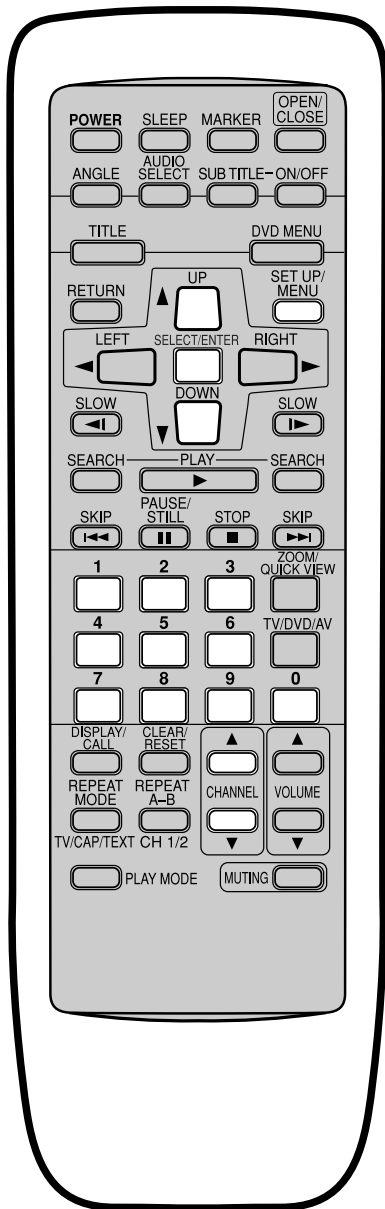

AUTOMATIC MEMORY TUNING

- 1 Press **MENU**.
- 2 Press **UP** or **DOWN** to select the "CH SET" option, then press **ENTER**.
- 3 Press **UP** or **DOWN** to select the "AUTO CH MEMORY", then press **ENTER**. The TV will begin memorizing all the channels available in your area.
- 4 Press **MENU** until the MENU screen is cleared.

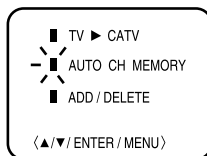
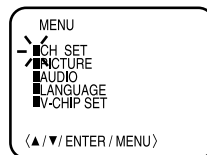

TO ADD/DELETE CHANNELS

- 1 Press **MENU**.
- 2 Press **UP** or **DOWN** to select the "CH SET" option, then press **ENTER**.
- 3 Press **UP** or **DOWN** to select the "ADD/DELETE", then press **ENTER**.
- 4 Select the desired channel to be memorized or deleted using **UP** or **DOWN**, or using the **Direct Channel Selection** buttons (10 keys, 0-9), or **CHANNEL UP** or **DOWN**.
- 5 Press **ENTER** to select the ADD or DELETE. If you select an unmemorized channel, the Channel indication will be red. If you select the ADD mode, the Channel indication changes from red to green and the channel will be memorized. If you select a memorized channel, the Channel indication will be green. If you select the DELETE mode, the Channel indication changes from green to red and the channel will be deleted from the memory.
- 6 Press **MENU** until the MENU screen is cleared.

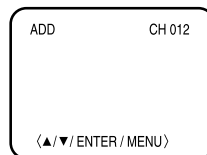
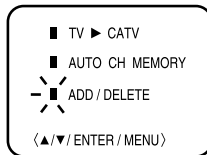
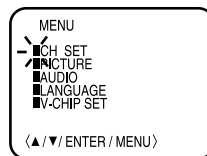

Setting the V-Chip

An age limitation can be set to forbid children to see and hear violent scenes or pictures for adults, etc. The TV/DVD corresponds to "TV RATING" and "MOVIE RATING". To use the V-Chip function, you must register a password.

TO REGISTER PASSWORD

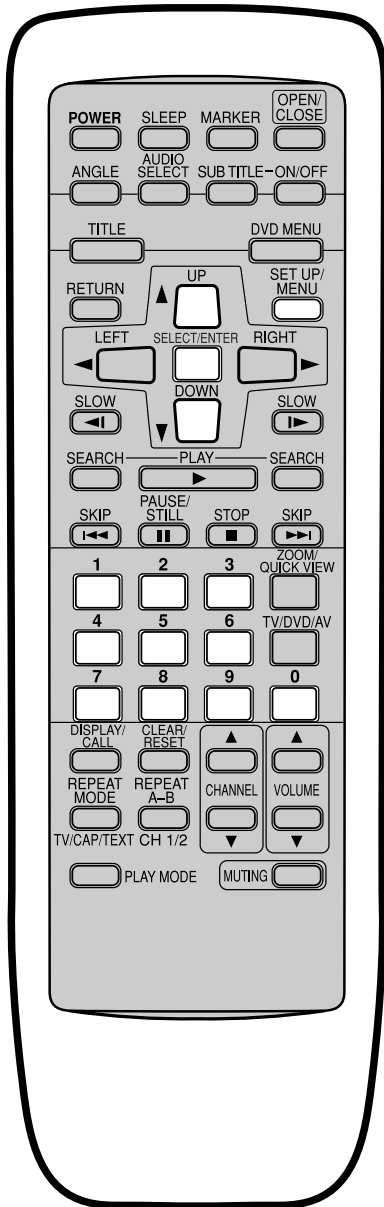

1 Press **MENU**.

2 Press **UP** or **DOWN** to select the "V-CHIP SET", then press **ENTER**.

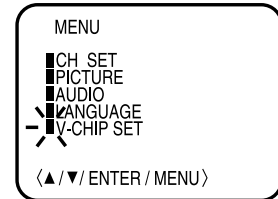

3 Enter the password (4 digits) using the **Direct Channel Selection** buttons (0-9), then press **ENTER**.

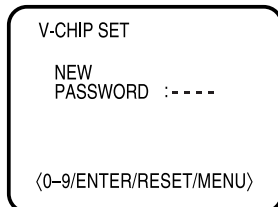

4 Enter the same password again for the safety, then press **ENTER**. Now the password was registered and V-Chip setting menu will appear on the display.

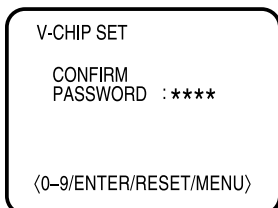

"*" appears instead of the number.

NOTES:

- If you forget the password, you cannot set the V-Chip.
- To avoid forgetting the password, write it down and keep in the safe place.

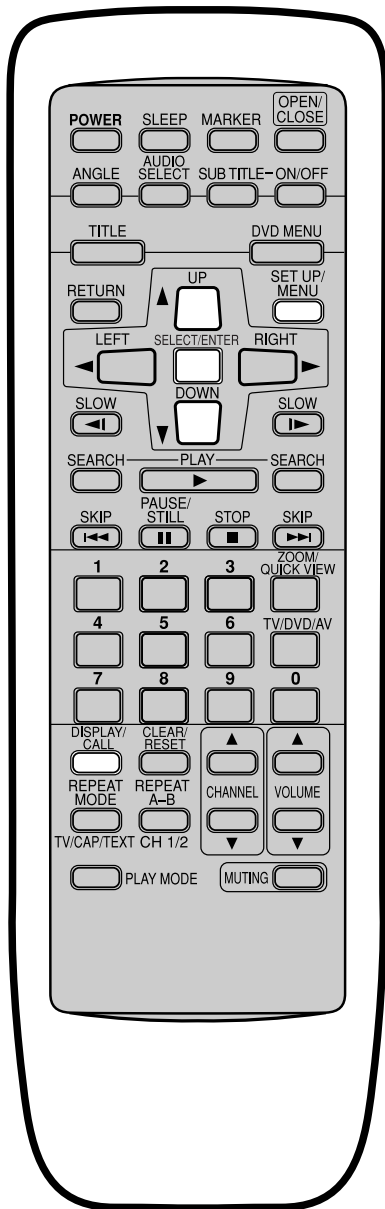

To use after the TV is protected
When the program applied to the V-Chip setting is received, enter the password. Protection can be cancelled.

NOTE:
The V-Chip function is activated only on programs and tapes that have the rating signal.

TO SET THE V-CHIP

1 In the V-CHIP SET menu, press **UP** or **DOWN** to select the "TV RATING", then press **ENTER**.

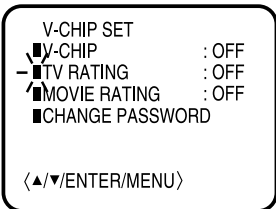

2 Press **UP** or **DOWN** to display the desired setting, then press **ENTER**.

OFF : TV RATING is not set
TV-Y : All children
TV-Y7 : 7 years old and above
TV-G : General Audience
TV-PG : Parental guidance
TV-14 : 14 years old and above
TV-MA : 17 years old and above

When you select TV- Y7, TV-PG, TV-14 or TV-MA, press **CALL** to show the contained rating. Press **UP** or **DOWN** to select the desired item you want. Press **ENTER** to select OFF.

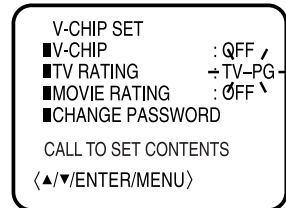

3 Press **UP** or **DOWN** to select the "MOVIE RATING", then press **ENTER**.

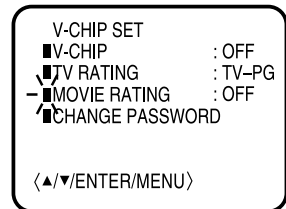

4 Press **UP** or **DOWN** to select desired rating, then press **ENTER**.

OFF : MOVIE RATING is not set
G : All ages
PG : Parental guidance
PG-13 : Parental guidance less than 13 years old
R : Under 17 years old
Parental guidance suggested
NC-17 : 17 years old and above
X : Adult only

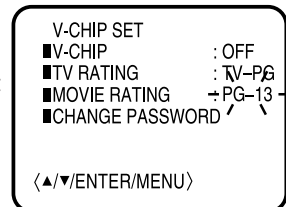

5 Press **UP** or **DOWN** to select "V-CHIP".

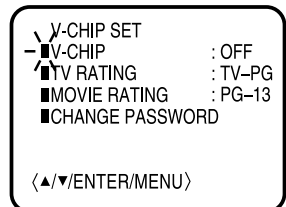

6 Press **ENTER** to Display "ON".
Now your settings were set into the memory.

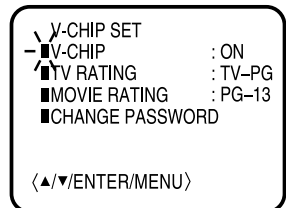

7 Press **MENU** until the MENU screen is cleared.

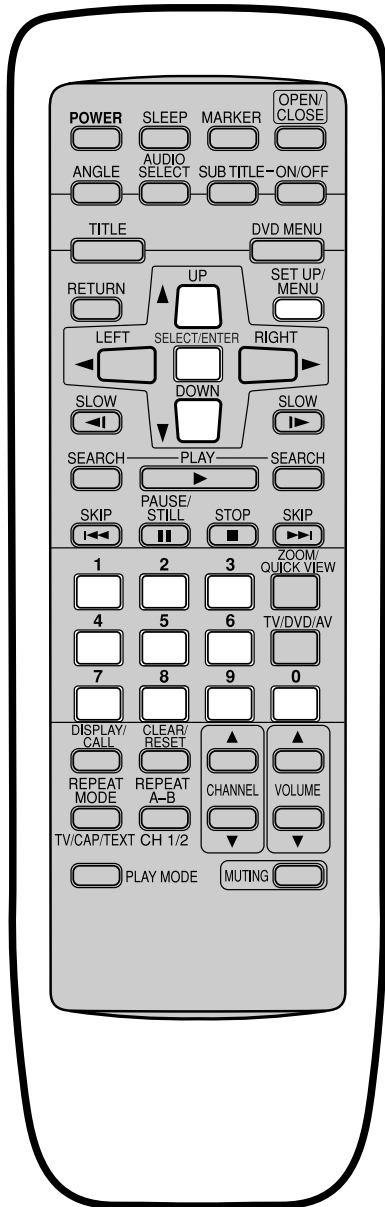

TO CHANGE PASSWORD

- 1 Press **MENU**.
- 2 Press **UP** or **DOWN** to select the "V-CHIP SET" option, then press **ENTER**.

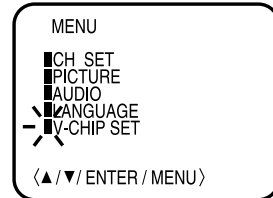

- 3 Enter the Password using the **Direct Channel Selection** button (0-9), then press **ENTER**.

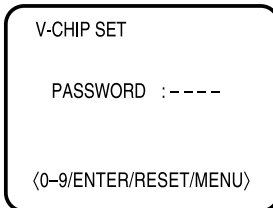

- 4 Press **UP** or **DOWN** to select "CHANGE PASSWORD", then press **ENTER**.

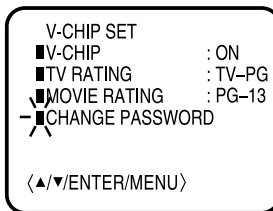

- 5 Enter the new password using the **Direct Channel Selection** button (0-9), then press **ENTER**.

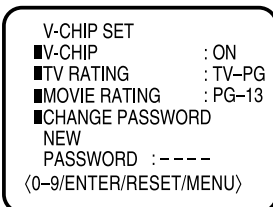

- 6 Enter the same password again for safety, then press **ENTER**.

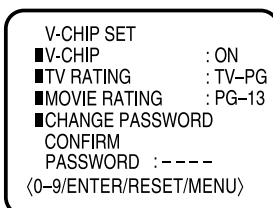

- 7 Press **MENU** repeatedly to return to normal screen.

Picture control adjustment

Picture controls are factory preset but you can adjust them individually as follows:

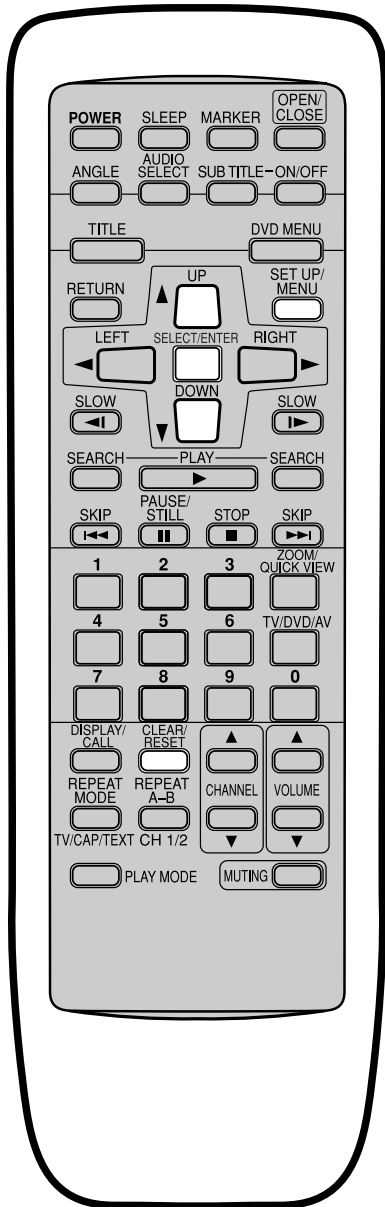

1 To display the picture adjustment screen, press **MENU**.

2 Press **UP** or **DOWN** to select the "PICTURE" option, then press **ENTER**.

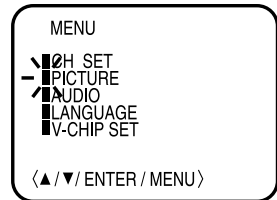

3 Press **ENTER** repeatedly to select the item you want to adjust.

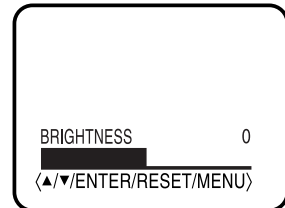

BRIGHTNESS → CONTRAST → COLOR → TINT → SHARPNESS

4 Press **UP** or **DOWN** to adjust the setting.

	+	-
BRIGHTNESS	increase brightness	decrease brightness
CONTRAST	increase contrast	decrease contrast
COLOR	be brilliant color	be pale color
TINT	be greenish color	be reddish color
SHARPNESS	makes picture clearer	makes picture softer

5 After your desired setting press **MENU** until the MENU screen is cleared.

RESET

Pressing **RESET** while making picture adjustments will return all adjustments to the factory preset levels.

NOTE:

- The On-screen display will disappear 6 seconds after finishing an adjustment. The settings can only be adjusted when they are displayed on the TV screen.
- The CONTRAST default setting is set to maximum at the factory.

Stereo and separate audio program (SAP)

The TV/DVD is equipped with a feature known as Multi-channel TV Sound or MTS. MTS broadcasts greatly enhance TV viewing by bringing you programs with high fidelity stereo sound. MTS also provides an extra channel called the Separate Audio Program or SAP which broadcasters can use to transmit a second language for bilingual transmission or for other purposes.

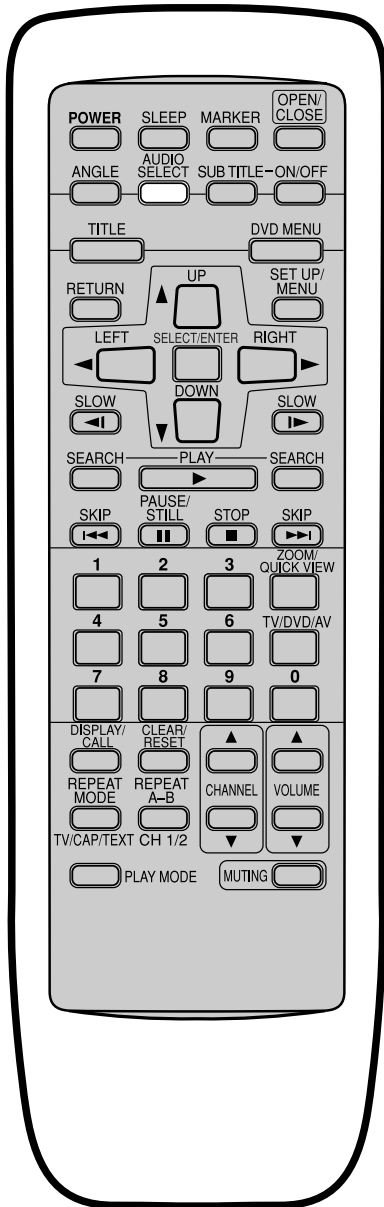

LISTENING TO STEREO SOUND

When the TV is turned on or a channel selection is made, make certain the STEREO appears on the screen. This means that "Stereo" broadcasting is available. You can enjoy stereo sound from the left and right speakers.



- When "Mono" broadcasting is received, no indication is displayed.
- If the broadcast signal is not strong enough or clear stereo sound is not available, press **AUDIO SELECT** to change to mono sound. The noise should be eliminated. Press it again to return to the stereo sound.

LISTENING TO SAP (SEPARATE AUDIO PROGRAM)

When the TV is turned on or a channel selection is made, make certain the SAP appears on the screen. This means that the "Separate Audio Program" broadcasting is available.

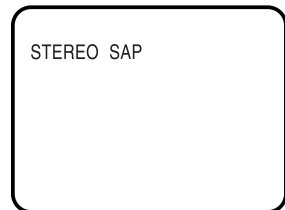

TO SELECT DESIRED SOUND

Press **AUDIO SELECT** to select the desired sound.

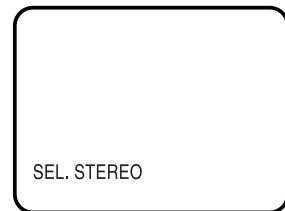

MONO+SAP BROADCASTING

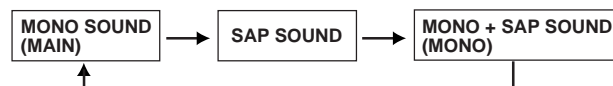

STEREO+SAP BROADCASTING

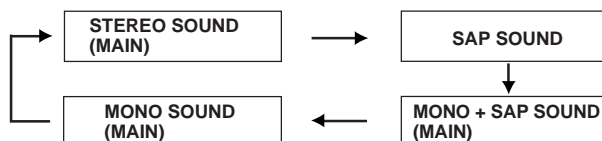

Sound control adjustment

Sound controls are factory preset but you can adjust them individually as follows:

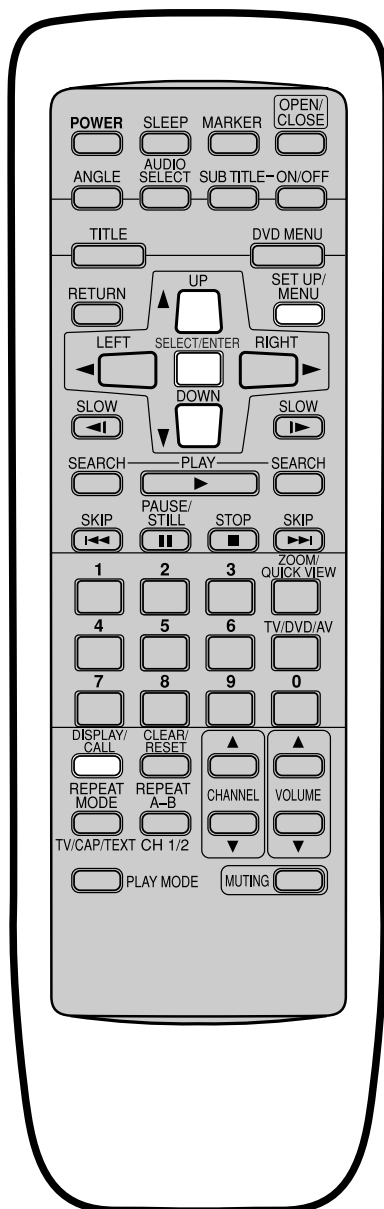

- 1 Press **MENU**.
- 2 Press **UP** or **DOWN** to select the "AUDIO" option, then press **ENTER**.

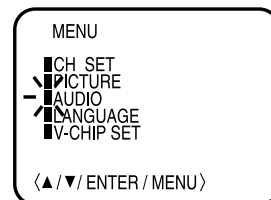

- 3 Press **ENTER** repeatedly to select the item you want to adjust.

BASS → TREBLE → BALANCE

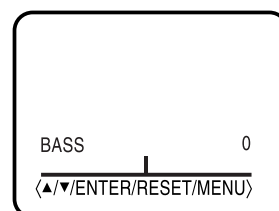

- 4 Press **UP** or **DOWN** to adjust the setting.

BASS:

Press **ENTER** until "BASS" appears on the screen, then press **UP** or **DOWN** to adjust the bass sound.

TREBLE:

Press **ENTER** until "TREBLE" appears on the screen, then press **UP** or **DOWN** to adjust the treble sound.

BALANCE:

Press **ENTER** until "BALANCE" appears on the screen, then press **UP** or **DOWN** to obtain an equal sound level from both speakers.

- 5 After your desired setting press **MENU** until the MENU screen is cleared.

RESET

Pressing **RESET** while making sound adjustments will return all adjustments to the factory preset levels.

NOTE:

The on-screen display will disappear 6 seconds after finishing an adjustment or by pressing **CALL**. The settings can only be adjusted when they are displayed on the TV screen.

Disc

The unit detects whether the disc loaded is a DVD disc or Audio CD and automatically sets the mode.

Compatible with DVD disc recorded in NTSC system and in PAL system

- To play back disc in either NTSC or PAL system, use a Multi-system TV.
- Do not use PAL TV to play back NTSC disc.
- Do not use NTSC TV to play back PAL disc.

Disc Notes

Do not play DVD-ROM, CD-ROM, CD-R, CDV, CD-G or Photo CD to prevent accidental erasure of prerecorded material.

This unit applies to DVD discs from Region 1 only. Other Region number discs cannot be played with this unit.

Title/Chapter/Track

Title

When two or more movies are recorded on a disc, the disc is divided into two or more sections. Each section is called a "TITLE".

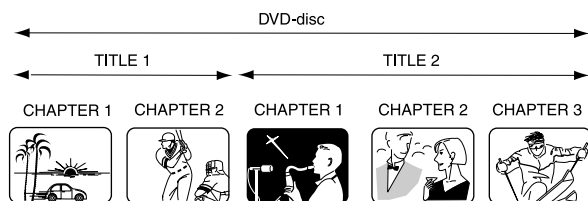

Chapter

The titles can be subdivided into many sections. Each section is called a "CHAPTER".

Track

An Audio CD can contain several items. These are assigned to the tracks.



Removing Disc from Case

Be sure to hold the edge of disc. Do not touch the surface of the disc. Pick up the disc gently from the case.

- Do not scratch the disc.
- Do not get dirt on the surface of the disc.
- Do not stick a label or adhesive tape on the disc.
- Do not drop or bend the disc.

Storing Disc

Insert the disc in the case to avoid risk of scratches, dirt or damage.

- Do not leave disc exposed to direct sunlight or in hot or humid places.

Cleaning Disc

Wipe the disc with a clean, dry cloth from center to edge.

- Do not wipe the disc round.
- Do not use liquid or aerosol cleaners.

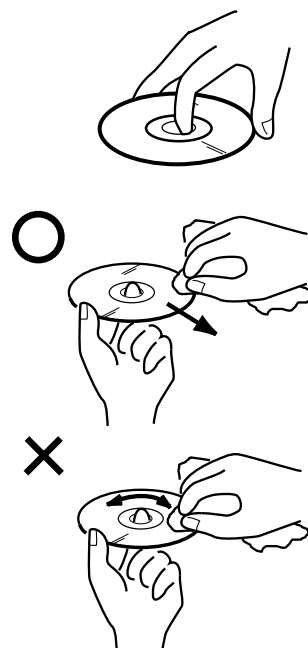

Setting setup language

The DVD set up language can be selected.

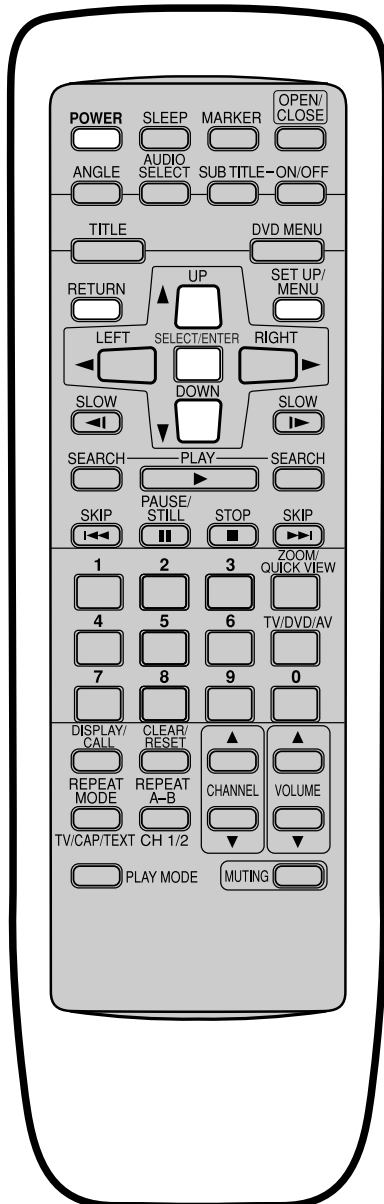

Preparation:

- Insert the AC cord plug into a standard 120V 60Hz polarized AC outlet.
- Press **POWER** on the unit or on the remote control to turn on the TV/DVD.
- When the unit is TV or AUX1/2 mode, press **OPEN/CLOSE** or **PLAY** to turn the DVD power to on.
- When using an amplifier, switch on the amplifier.

- 1 Press **SET UP** in the stop mode. (Confirm DVD power is on.) The DVD set up menu screen will appear.

1) RATING LEVEL
2) AUDIO
3) SUBTITLE
4) TV SCREEN
5) OSD DISPLAY
6) MENU LANGUAGE
7) AUDIO OUTPUT
8) SETUP LANGUAGE

PRESS RETURN TO EXIT

- 2 Press **UP** or **DOWN** to select **SETUP LANGUAGE**, then press **SELECT**.

1) RATING LEVEL
2) AUDIO
3) SUBTITLE
4) TV SCREEN
5) OSD DISPLAY
6) MENU LANGUAGE
7) AUDIO OUTPUT
8) SETUP LANGUAGE

PRESS RETURN TO EXIT

- 3 Press **UP** or **DOWN** to select desired language(e.g. ENGLISH), then press **SELECT**.

SETUP LANGUAGE

ENGLISH
FRANCAIS
DEUTSCH
ESPAÑOL
ITALIANO

PRESS RETURN TO EXIT

- 4 To make SET UP screen disappear, press **RETURN** while the SET UP screen is being appeared.

DVD power:

When not in use the DVD or changed from DVD mode to the TV or AUX1/2 mode after used DVD, the DVD section will automatically turn off to save electric power consumption.

To turn the DVD power to on press **OPEN/CLOSE** or **PLAY**.

DVD set up menu:

The DVD set up menu will appear in the DVD mode (DVD power is on) and also the DVD is stop mode.

Playback procedure

AUTOMATIC POWER ON:

The TV/DVD will turn on automatically when **OPEN/CLOSE** or **PLAY** is pressed.

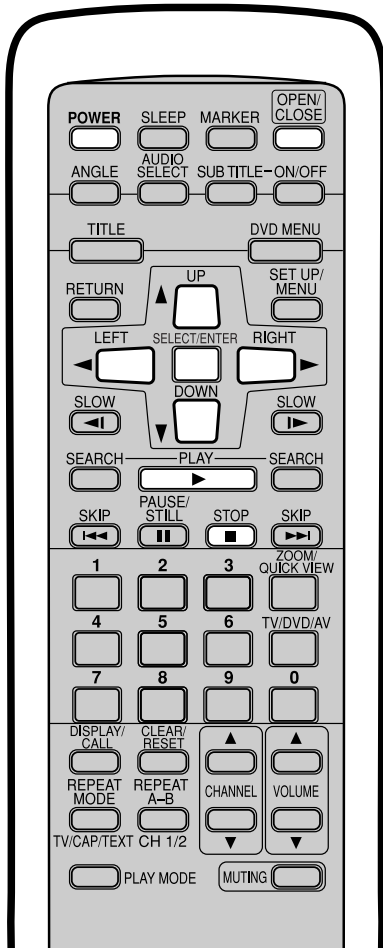

- 1 Press **OPEN/CLOSE**.
The disc tray will open.



- 2 Place a disc onto the tray.
Hold the disc, position it with the printed label side up, align it with the guides, and place it in its proper position.

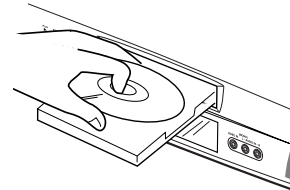

- 3 Press **PLAY** or **OPEN/CLOSE**.
The disc tray closes automatically. On the TV-screen, "CLOSE" changes to "READING" and then playback commences.

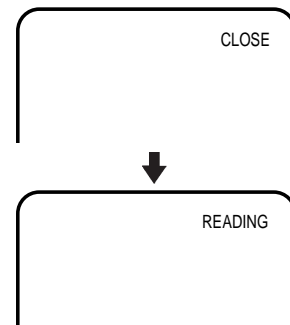

- A menu screen will appear on the TV screen, if the disc has a menu feature.

- 4 Press **UP/DOWN** or **LEFT/RIGHT** to select title.

- 5 Press **SELECT**.
• Title is selected and play commences.

- 6 Press **STOP** to end playback.
 - Press **PLAY** to resume playback (from the scene point). (The unit records the stopped point, depending on the disc.)
 - If you press **STOP** again or unload the disc, the unit will clear the stopped point.

- 7 To stop the playback, press **STOP**.
Then press **OPEN/CLOSE** to open the disc tray. Remove the disc and then press **POWER**.
The disc tray closes automatically and unit turns off.

NOTE:

- If a non-compatible disc is loaded, "INCORRECT DISC" will appear on the TV screen.
- Some discs may take one minute until playback will start.
- When you set a single-faced disc face downward and press **PLAY** or **CLOSE**, "READING" will appear on the display for 10 seconds and then "NO DISC" will continued to be displayed.
- Some playback operations of DVDs may be intentionally fixed by software producers. Since this unit plays DVDs according to the disc contents the software producers designed, some playback features may not be available. Also refer to the instructions supplied with the DVDs.
- When playing DTS-encoded DVDs, excessive noise will be heard from the analogue stereo outputs. To avoid possible damage to the audio system, the consumer should take proper precautions when the analogue stereo outputs of the DVD player are connected to an amplification system.

Special playback

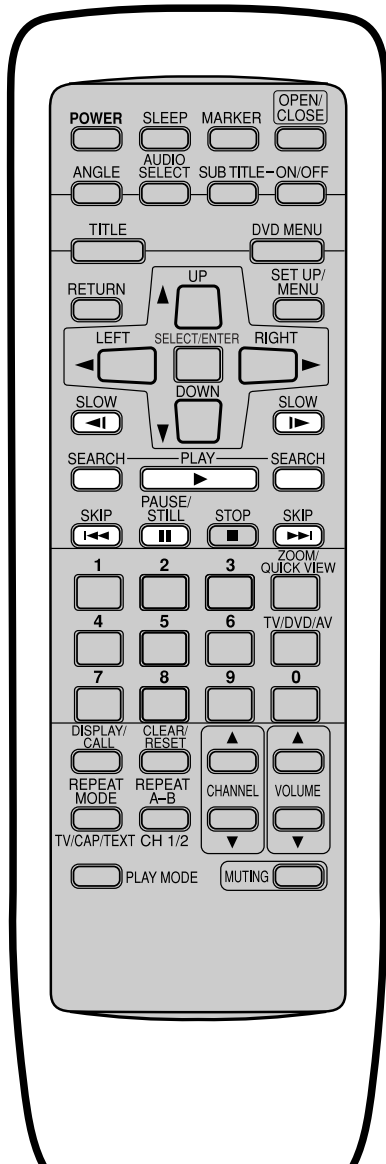

NOTE:

- You can not skip a chapter in the still mode.
- The unit is capable of holding a still video image or on screen display image on your television screen indefinitely. If you leave the still video image or on screen display image displayed on your TV for an extended period of time, you risk permanent damage to your television screen. Projection televisions are very susceptible.

Fast Forward Playback

Press and hold **SEARCH (RIGHT)** during normal playback.

- Normal playback is resumed when the button is released.

Review Playback

Press and hold **SEARCH (LEFT)** during normal playback.

- Normal playback is resumed when the button is released.

At first the speed of Fast Forward or Review Playback is slow, but speeds up after 5 seconds.

Still Playback

Press **PAUSE/STILL** during normal playback to pause playback.

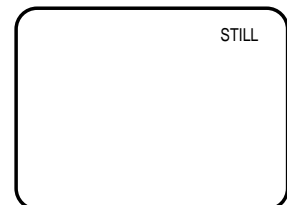

To resume normal playback press **PLAY**.

Frame Advance

Press **PAUSE/STILL** during still playback.

One frame is advanced when you press **PAUSE/STILL** once.

To resume normal playback press **PLAY**.

Slow-motion Playback

Press **SLOW(◀|)** Reverse or **SLOW(|▶)** Forward during normal playback or still playback.

- To resume normal playback, press **PLAY**.
- To resume the still playback, press **PAUSE/STILL**.

Locating a chapter

Press **SKIP(▶▶)** Forward or **SKIP(◀◀)** Reverse during playback to locate a chapter that you want to watch. Each time you press the button, a chapter is skipped.

Zooming / Locating desired scene

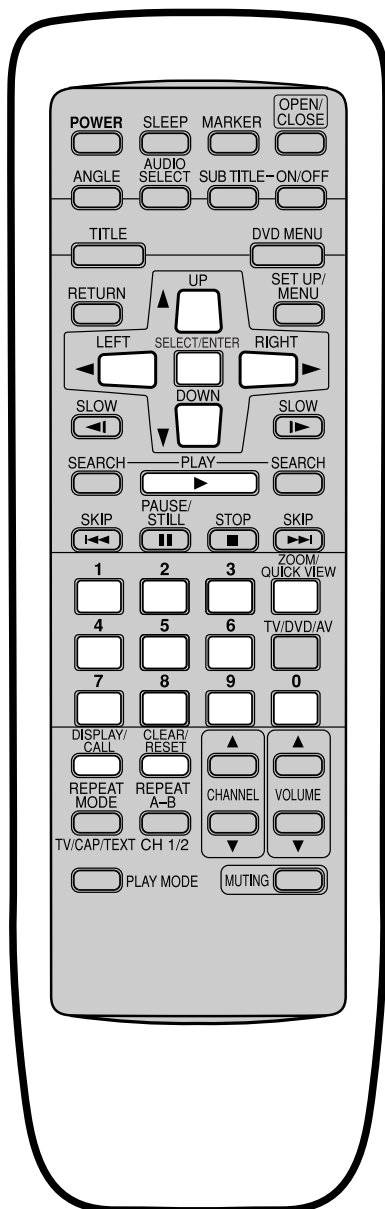

NOTE:

You can select the Pause, Slow or Search playback in the zoom mode. However, you cannot zoom in during the Pause, Slow or Search playback.

Zooming

In this unit you will zoom in on the frame image. You then will make selections by switching the position of the frame. The frame image is displayed at a 1:4 view.

- 1 Press **ZOOM** during playback. The center part of the image will be zoomed in.

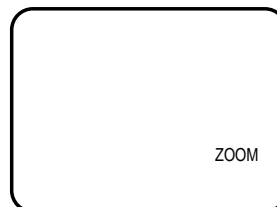

- 2 Press **UP/DOWN** or **LEFT/RIGHT** to view a different part of the frame. You may move the frame twice from the center position to UP, DOWN, LEFT or RIGHT direction.

- 3 In the zoom mode press **ZOOM** again to return to a 1:1 view.

Locating desired scene

Use the title, chapter and time recorded on the disc to locate the desired point to play back.

- 1 Press **DISPLAY** during playback.

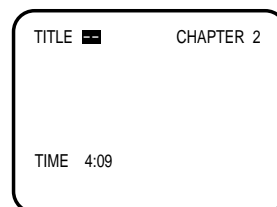

- 2 Press **UP/DOWN** or **LEFT/RIGHT** to select the title, chapter or time.

- 3 Press **Number buttons (0-9)** to change the number.

- If you input a wrong number, press **CLEAR**.
- Refer to the package supplied with the disc to check the numbers.

- 4 Press **SELECT** or **PLAY**.

- Playback starts.
- When you change the title, playback starts from the Chapter 1 of the selected title.
- Some discs may not work in the above operation.

Repeat playback

Title, Chapter, Track Playback

Press **REPEAT MODE** during playback.

Each time you press the button, the on-screen display changes as below.

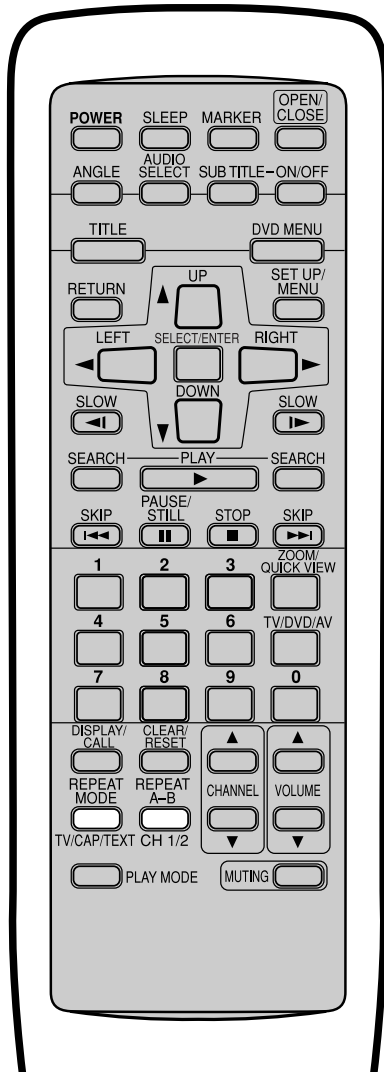

DVD

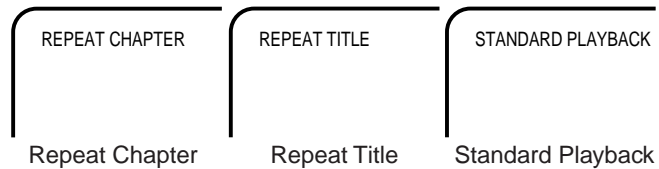

Audio CD

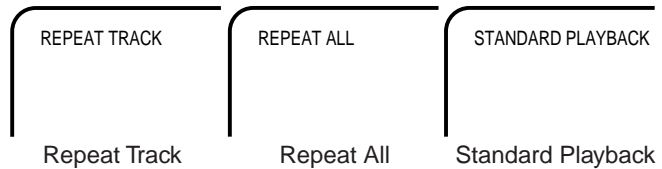

To resume normal playback

Press **REPEAT MODE** several times until "STANDARD PLAYBACK" appears.

A-B Repeat Playback

Use the title, chapter and time recorded on the disc to locate the desired point to play back.

- 1 Press **REPEAT A-B** during playback.
The start point is selected.

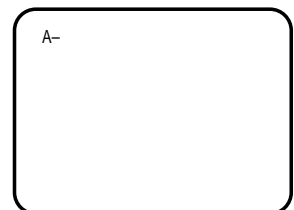

- 2 Press **REPEAT A-B** again.
The end point is selected. Playback starts at the point that you selected. Playback stops at the end point, returns to Point A automatically, then starts again.

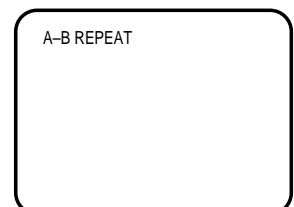

To resume normal playback press **REPEAT A-B** again.
"STANDARD PLAYBACK" appears on the screen.

NOTE:

- Some discs may not work with the repeat operation.
- A-B repeat can function only within a chapter.
- In A-B repeat mode, subtitles near point A or B may not appear.
- During the A-B Repeat Playback the following buttons will not operate: AUDIO, ANGLE, SUBTITLE and DISPLAY.
- You may not be able to set A-B Repeat, depending on the scenes of the DVD.
- A-B repeat does not work with an interactive DVD.

Program playback (audio CD)

You can arrange the order of tracks on the disc.

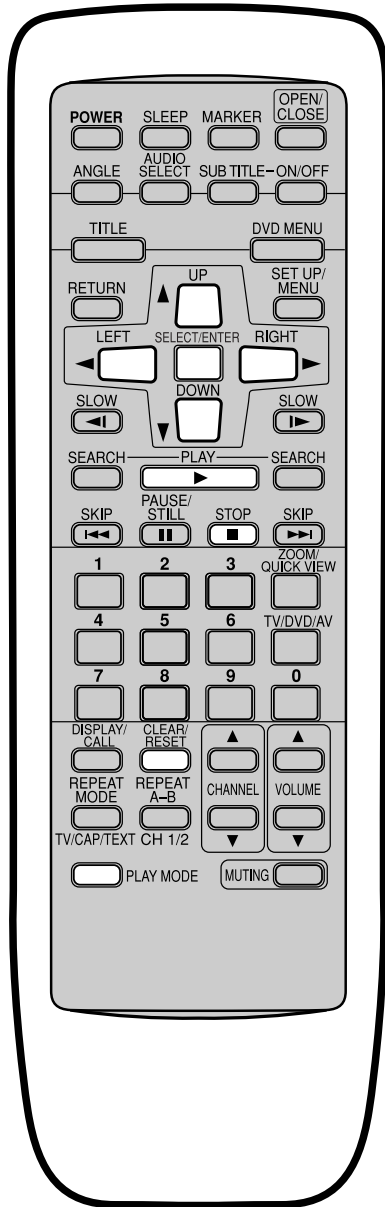

1 Press **PLAY MODE** in the stop mode.

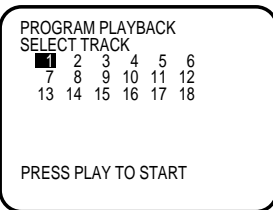

2 Press **UP/DOWN** or **LEFT/RIGHT** to select the desired track.

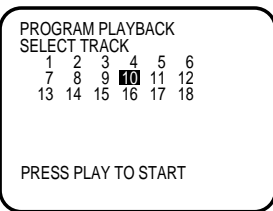

3 Press **SELECT**.

- The selected track is memorized.
- To program others, repeat Step 2 and 3.

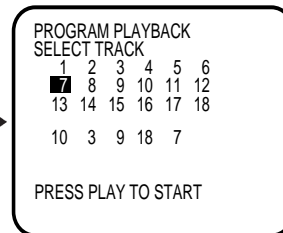
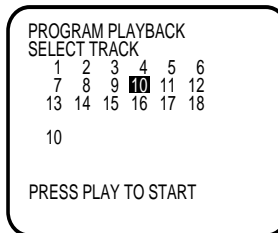

- Press **CLEAR** to delete the programmed tracks.

4 Press **PLAY**.

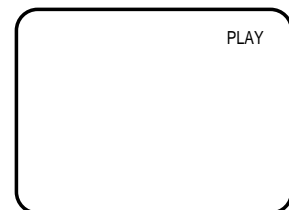

NOTE:

You may not be able to use Program Playback depending on the CD.

- The programming screen automatically appears when the program playback is finished.
- To cancel program play, press **STOP**, then press **PLAY MODE**. "STANDARD PLAYBACK" appears on the screen.
- The program is canceled when you open the disc tray or turn the power off.

Marking desired scenes

The unit stores the points which that you want to watch again. You can resume playback from that scene.

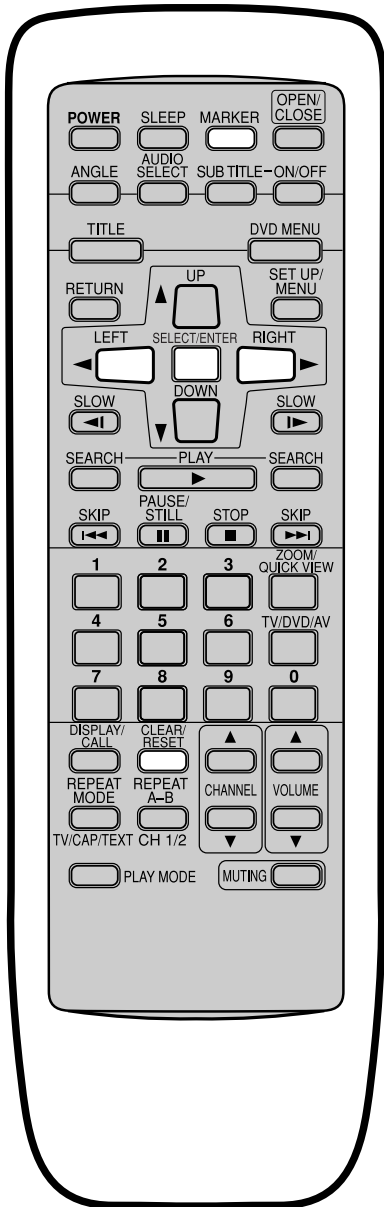

NOTE:

- This operation may not work with some discs.
- The marking is canceled when you open the disc tray.
- Some subtitles recorded around the marker may fail to appear. [DVD]

Marking the Scenes

1 Press **MARKER** during playback.

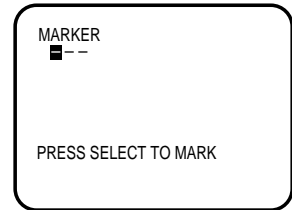

2 Press **SELECT** during playback at the desired scene.

- Up to 3 scenes can be selected.

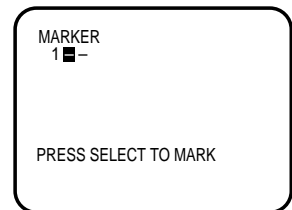

Returning to the scenes

1 Press **MARKER** during playback.

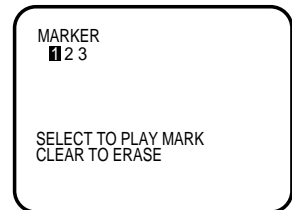

2 Press **LEFT** or **RIGHT** to select the INDEX number.

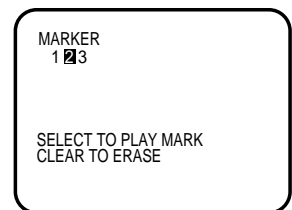

3 Press **SELECT**.
Playback starts from the marked scene.

To Cancel the Mark

1 Press **MARKER**.

2 Press **LEFT** or **RIGHT** to select the index number.

3 Press **CLEAR**.

Changing soundtrack language

You can select the language when you play a multilingual disc.

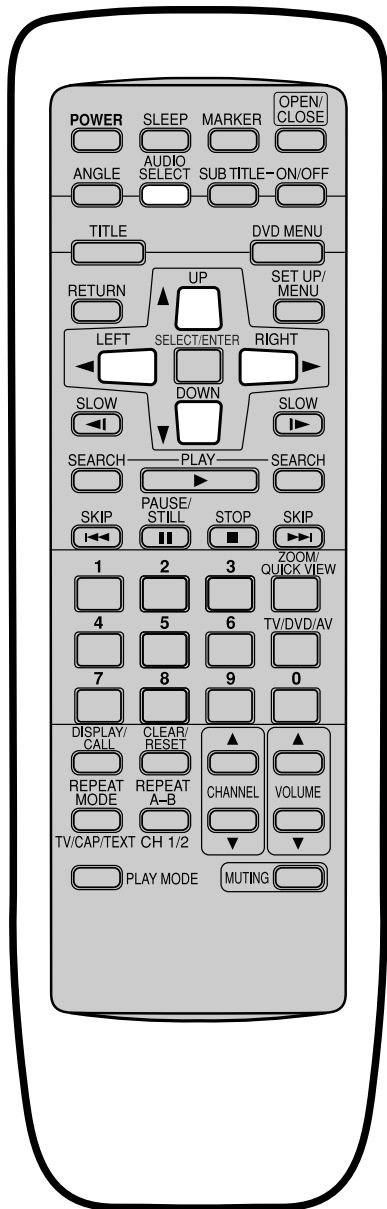

1 Press **AUDIO SELECT** during playback.

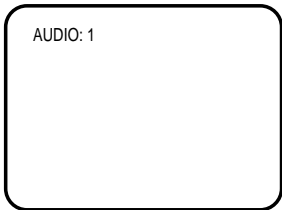

If "VOCAL OFF" appears on the screen, you can select "ON" or "OFF" with **LEFT** or **RIGHT**. (Depending on the DVD, the vocal will not be listened with digital out connection.)

2 Press **UP** or **DOWN** until the desired language is selected.

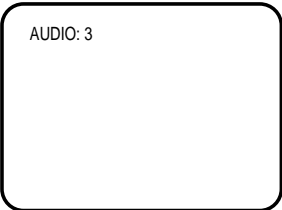

3 Press **AUDIO** to make display disappear.

NOTE:

- If the desired language is not heard after pressing the button several times, the language is not recorded on the disc.
- Changing soundtrack language is canceled when you open the disc tray or turn the power off. The initial default language or available language will be heard if the disc is played back again.

Subtitles

Turning the Subtitles On and Off

When playing back a disc recorded with subtitles, you can turn the subtitle on or off.

Press **SUB TITLE** during playback. Then press **ON/OFF** to select ON or OFF Subtitles appear on the screen.

SUBTITLE: 1 ON

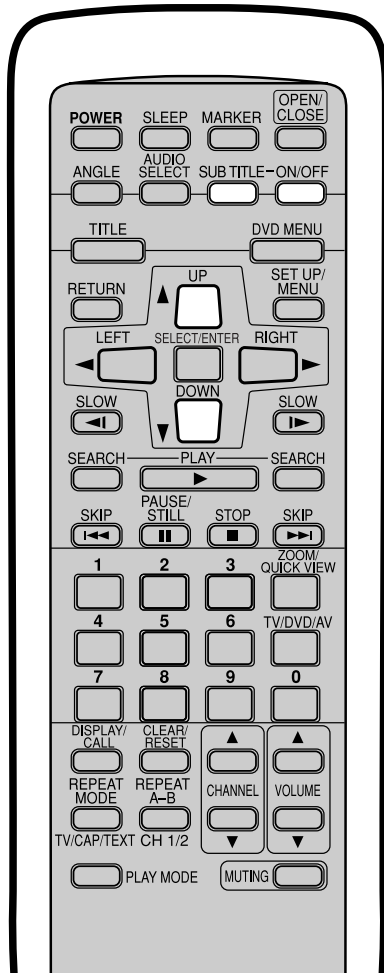

Changing the subtitle language

You can select the language when playing back a disc recorded with multi-lingual subtitles.

1 Press **SUB TITLE** during playback.

SUBTITLE: 1 ON

2 Press **UP** or **DOWN** until the desired language is selected.

SUBTITLE: 2 ON

NOTE:

- If desired language is not selected after pressing the button several times, the language is not recorded on the disc.
- Changing subtitle language is canceled when you open the disc tray.
- Depending on the DVD, you may not be able to turn the subtitles on even if they are recorded on it. Depending on the DVD, you may not be able to turn the subtitles off. Depending on the DVD, you may not be able to change the subtitles even if multilingual subtitles are recorded on it. While playing the DVD, the subtitle may change when: -you open or close the disc tray -you change the title.
- In some cases, the subtitle language is not changed to the selected one immediately.

3 Press **SUB TITLE** to make display disappear.

Changing angles / Title selection / DVD menu

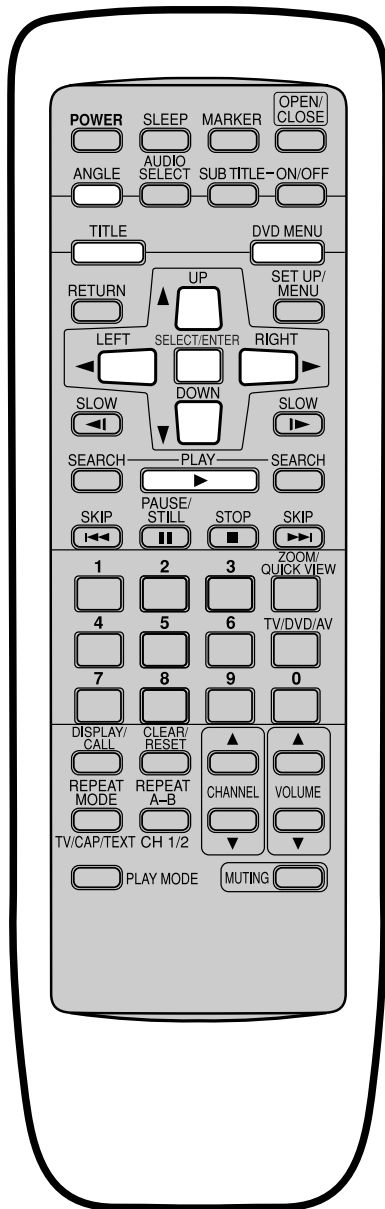

NOTE:

- Depending on the DVD, you may not be able to change the angles even if multi-angles are recorded on the DVD.
- Depending on the DVD, you may not be able to select the title. Depending on the DVD, a "title menu" may simply be called a "menu" or "title" in the instructions supplied with the disc.

Changing Angles

When playing back a disc recorded with multi-angle facility, you can change the angle that you are viewing the scene from.

1 Press **ANGLE** during playback.

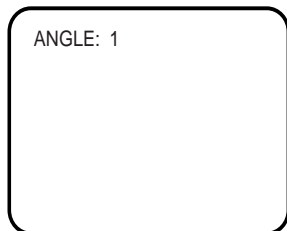

2 Press **UP** or **DOWN** until the desired angle is selected.

3 Press **ANGLE** to make display disappear.

Title selection

Two or more titles are recorded on some discs. If the title menu is recorded on the disc, you can select the desired title.

1 Press **TITLE** during playback.
Title menu appears on the screen.

2 Press **UP/DOWN** or **LEFT/RIGHT** to select the desired title.

3 Press **SELECT** or **PLAY**.
The playback of the selected title starts.

DVD menu

Some DVDs allows you to select the disc contents using the menu.

When you play back these DVDs, you can select the sub-title language, sound-track language, etc. using the DVD menu.

1 Press **DVD MENU** during playback.
The DVD menu appears on the screen.

- Press **DVD MENU** again to resume playback at the scene.

2 Press **UP/DOWN** or **LEFT/RIGHT** to select the desired item.

3 Press **SELECT**.
The menu continues to another screen. Repeat steps 2 and 3 to set the item completely.

Rating level setting

Some discs are specified not suitable for children. Such discs can be limited to play back with the unit.

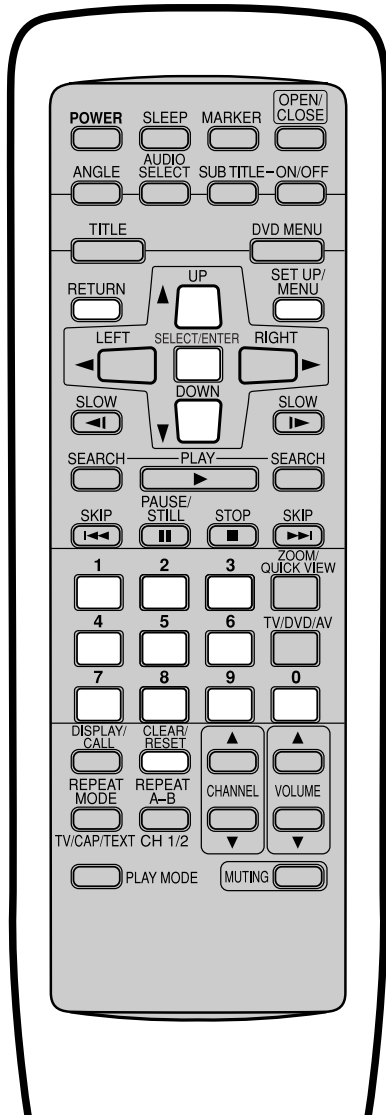

NOTE:

- If each setup (P.37~44) has been completed, the unit can always be worked under the same conditions (especially with DVD discs). Each setup will be retained in the memory if you turn the power off.
- Depending on the discs, the unit cannot limit playback.
- Some discs may not be encoded with specific rating level information though its disc jacket says "adult." For those discs, the age restriction will not work.

1 Press **SET UP** in the stop mode.

2 Then press **UP** or **DOWN** to select **RATING LEVEL**. Press **SELECT**.

1) RATING LEVEL
2) AUDIO
3) SUBTITLE
4) TV SCREEN
5) OSD DISPLAY
6) MENU LANGUAGE
7) AUDIO OUTPUT
8) SETUP LANGUAGE
PRESS RETURN TO EXIT

3 Press **UP** or **DOWN** to select your desired level, then press **SELECT**.

RATING SELECT LEVEL
1 NORMAL
2
3
VIEWABLE 4
PROHIBITED 5
6
7
8 ADULT
PRESS RETURN TO EXIT

- **Level 1 NORMAL:** DVD software for adults cannot be played back.
- **Level 8 ADULT:** All DVD software can be played back.
- Select from the level 1 to level 8. The limitation will be more severe as the level number is lower.

4 Press **number buttons (0-9)** to input a 4-digit password, then press **SELECT**.

RATING LEVEL IS SET AT 4.
TO LOCK THE LEVEL ENTER THE 4-DIGIT PASSWORD.

1234 UNLOCK
PRESS RETURN TO EXIT

- If you input a wrong number, press **CLEAR**.

5 Press **RETURN**.

Setting is finished and the SET UP screen appears. The rating is locked and the setting cannot be changed unless you enter the correct password.

To unlock the rating

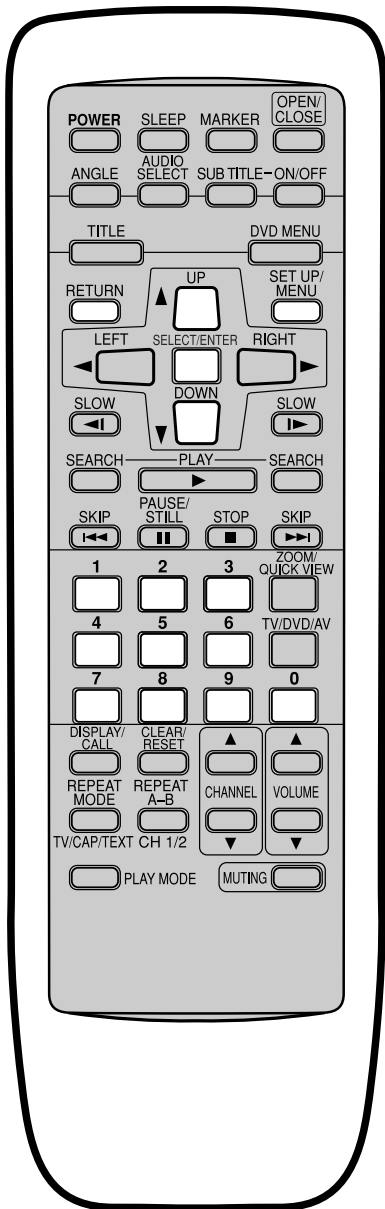

1 Press **SET UP** in the stop mode.

2 Press **UP** or **DOWN** to select **RATING LEVEL**, then press **SELECT**.

1) RATING LEVEL
2) AUDIO
3) SUBTITLE
4) TV SCREEN
5) OSD DISPLAY
6) MENU LANGUAGE
7) AUDIO OUTPUT
8) SETUP LANGUAGE
PRESS RETURN TO EXIT

3 Press **number buttons (0-9)** to enter the passwords, then press **SELECT**.

RATING
PASSWORD IS NEEDED
TO CHANGE THE LEVEL.
PLEASE ENTER THE
4-DIGIT PASSWORD

1234 LOCK
PRESS RETURN TO EXIT

4 Press **SELECT**.

RATING SELECT LEVEL
1 NORMAL
2
3
4 VIEWABLE
5 PROHIBITED
6
7
8 ADULT
PRESS RETURN TO EXIT

5 Press **RETURN**.
Now the rating is unlocked.

RATING
LEVEL IS SET AT 4.
TO LOCK THE LEVEL
ENTER THE 4-DIGIT
PASSWORD.

---- UNLOCK
PRESS RETURN TO EXIT

NOTE:

Do not forget the password. If you forget the password, contact the dealer that you purchased it, because you cannot clear the password.

Setting audio soundtrack language

The same audio soundtrack language can always be selected even if you replace the disc or turn the power off.

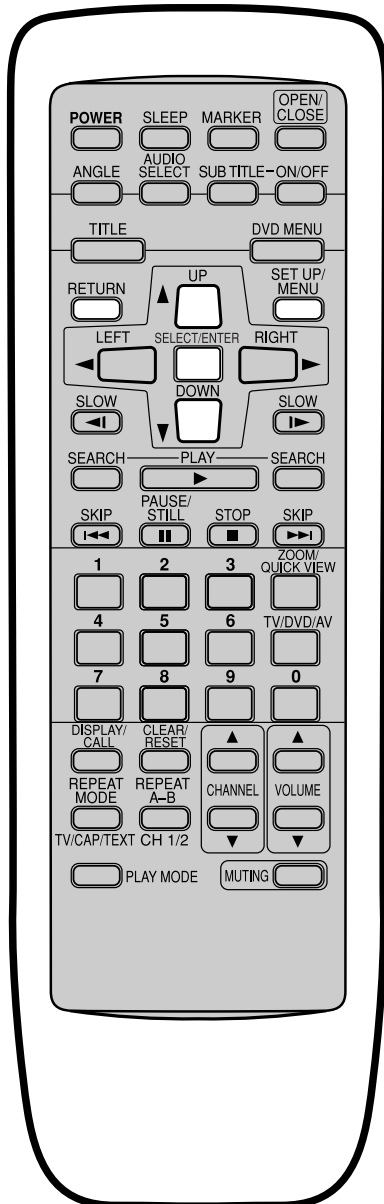

NOTE:

If the selected language is not recorded on the disc, the original language is heard.

1 Press **SET UP** in the stop mode.

2 Press **UP** or **DOWN** to select **AUDIO**, then press **SELECT**.

1) RATING LEVEL
2) **AUDIO**
3) SUBTITLE
4) TV SCREEN
5) OSD DISPLAY
6) MENU LANGUAGE
7) AUDIO OUTPUT
8) SETUP LANGUAGE
PRESS RETURN TO EXIT

3 Press **UP** or **DOWN** to select your desired language, then press **SELECT**.

AUDIO: 3

- **ORIGINAL:** The unit will select the first priority language of each disc.
- **OTHER:** If you want to select the another language, enter the language code. (See the Language Code List on the page 45.)

4 To make **SET UP** screen disappear, press **RETURN** while the **SETUP** screen is being displayed.

Setting Subtitle Language

The same subtitle language can always be selected even if you replace the disc or turn the power off.

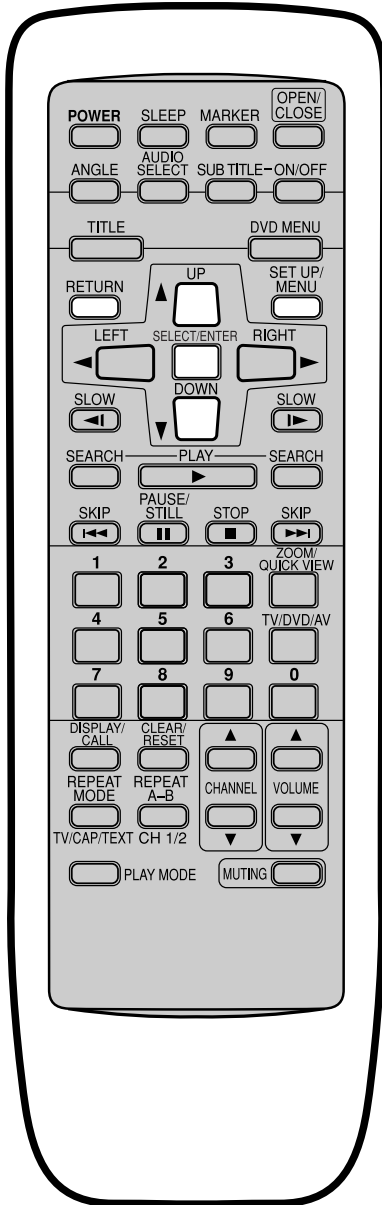

1 Press **SET UP** in the stop mode.

2 Press **UP** or **DOWN** to select **SUBTITLE**, then press **SELECT**.

1) RATING LEVEL
2) AUDIO
3) **SUBTITLE**
4) TV SCREEN
5) OSD DISPLAY
6) MENU LANGUAGE
7) AUDIO OUTPUT
8) SETUP LANGUAGE
PRESS RETURN TO EXIT

3 Press **UP** or **DOWN** to select your desired language, then press **SELECT**.

SUBTITLE LANGUAGE PREFERENCE
AUTOMATIC
ENGLISH
OTHER ----
PRESS RETURN TO EXIT

AUTOMATIC:

- The unit will automatically select the same language in the AUDIO setting.
- When the unit selects the same language as the AUDIO, the subtitles will not appear during playback.
- When you do not use the same language as the AUDIO, the subtitles will appear during playback.

OTHER:

If you want to select another language, enter the language code (see the language code list on page 45).

4 To make SET UP screen disappear, press **RETURN** while the SET UP screen is being displayed.

NOTE:

If the selected language is not recorded on the disc, the first-priority language is selected.

Setting the aspect ratio of TV screen

You can select the aspect ratio for your TV.

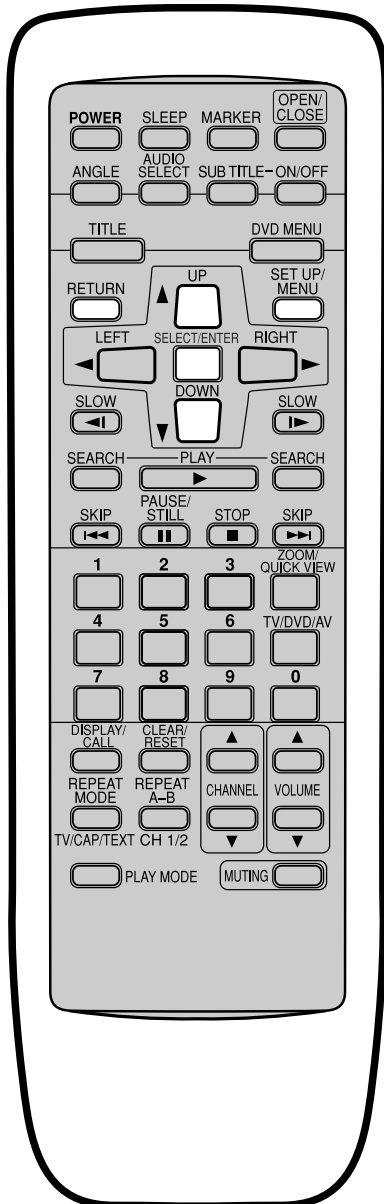

NOTE:

If the DVD disc is not formatted in the pan & scan style, it displays 4:3 style.

1 Press **SET UP** in the stop mode.

2 Press **UP** or **DOWN** to select TV SCREEN, then press **SELECT**.

- 1) RATING LEVEL
- 2) AUDIO
- 3) SUBTITLE
- 4) TV SCREEN**
- 5) OSD DISPLAY
- 6) MENU LANGUAGE
- 7) AUDIO OUTPUT
- 8) SETUP LANGUAGE

PRESS RETURN TO EXIT

3 Press **UP** or **DOWN** to select your desired screen type, then press **SELECT**.

TV SCREEN
SELECT TV TYPE AND
PICTURE TYPE

- 4 : 3
- 4 : 3 PANSCAN
- 16 : 9 WIDE

PRESS RETURN TO EXIT

4:3

Select this mode when connecting to a conventional TV, when playing back a wide screen-DVD disc.

It displays the wide picture with black bands at top and bottom of screen.

4:3 PANSCAN

It display the wide picture on the whole screen with a left and right edges automatically cut off.

16:9 WIDE

Select this mode when connecting to wide-screen TV.

A Wide screen picture is displayed full size.

4 To make SET UP screen disappear, press **RETURN** while the SET UP screen is being displayed.

Setting on Screen display

On screen display (concerning of deck operations, ex, PLAY, STOP, SERCH or so on) can be switched on or off when you press the buttons.

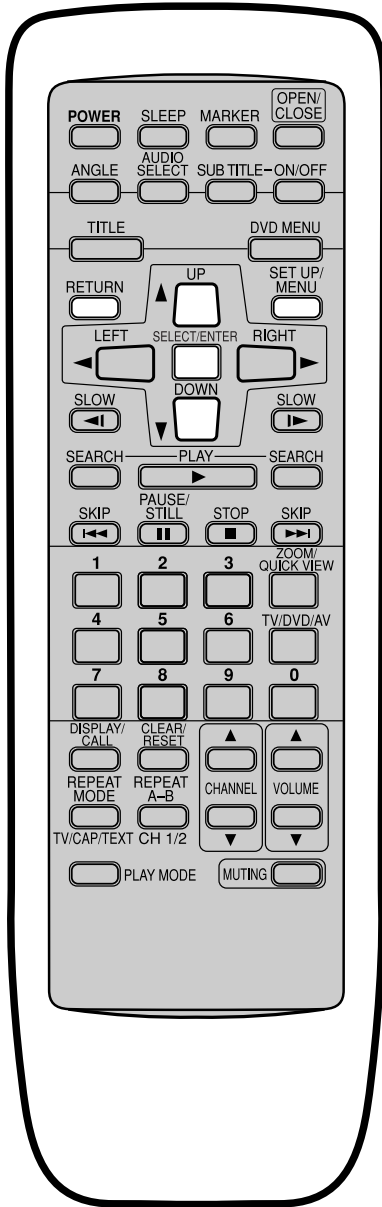

1 Press **SET UP** in the stop mode.

2 Press **UP** or **DOWN** to select OSD DISPLAY, then press **SELECT**.

1) RATING LEVEL
2) AUDIO
3) SUBTITLE
4) TV SCREEN
5) **OSD DISPLAY**
6) MENU LANGUAGE
7) AUDIO OUTPUT
8) SETUP LANGUAGE
PRESS RETURN TO EXIT

3 Press **UP** or **DOWN** to select ON or OFF, then press **SELECT**.

OSD DISPLAY
ON
OFF
PRESS RETURN TO EXIT

ON: On screen displays appear when you press the buttons (factory setting).

OFF: On screen displays do not appear when you press the buttons.

4 To make SET UP screen disappear, press **RETURN** while the SET UP screen is being displayed.

Setting menu language

You can select the language of the disc menu messages of DVDs.

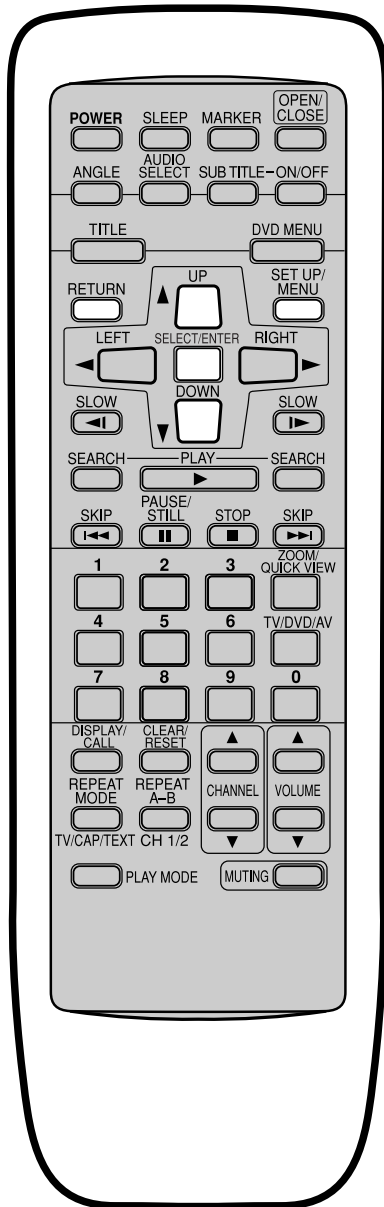

1 Press **SET UP** in the stop mode.

2 Press **UP** or **DOWN** to select **MENU LANGUAGE**, then press **SELECT**.

1) RATING LEVEL
2) AUDIO
3) SUBTITLE
4) TV SCREEN
5) OSD DISPLAY
6) MENU LANGUAGE
7) AUDIO OUTPUT
8) SETUP LANGUAGE
PRESS RETURN TO EXIT

3 Press **UP** or **DOWN** to select your desired language, then press **SELECT**.

MENU LANGUAGE
PREFERENCE FOR DISC
ENGLISH
OTHER ----

PRESS RETURN TO EXIT

OTHER: Other language can be selected.
(See the Language Code List on page 45.)

4 To make **SET UP** screen disappear, press **RETURN** while the **SET UP** screen is being displayed.

Setting audio output

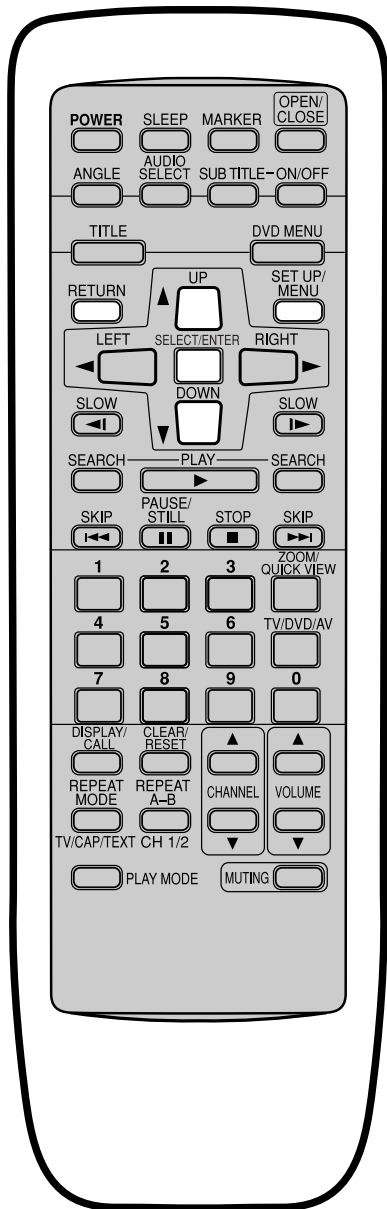

1 Press **SET UP** in the stop mode.

2 Press **UP** or **DOWN** to select **AUDIO OUTPUT**, then press **SELECT**.

- 1) RATING LEVEL
- 2) AUDIO
- 3) SUBTITLE
- 4) TV SCREEN
- 5) OSD DISPLAY
- 6) MENU LANGUAGE
- 7) **AUDIO OUTPUT**
- 8) SETUP LANGUAGE

PRESS RETURN TO EXIT

3 Press **UP** or **DOWN** to select **DIGITAL** or **ANALOGUE**, then press **SELECT**.

AUDIO OUTPUT

- DIGITAL
- ANALOGUE

PRESS RETURN TO EXIT

DIGITAL:

When the unit is connected to an amplifier with any built-in decoder among Dolby Digital or MPEG or DTS.

ANALOGUE

- When the unit is connected to an amplifier without any built-in decoder among Dolby Digital or MPEG or DTS.
- When the unit is connected with RF cable to the TV.

4 To make **SET UP** screen disappear, press **RETURN** while the **SET UP** screen is being displayed.

NOTE:

- Do not set to **DIGITAL** when you connect the unit to an amplifier without any built-in decoder such as a Dolby Digital using the optical or coaxial digital cable. Otherwise it may cause such a high level noise that it may be harmful to your ears and damage your speakers.
- When you set to **DIGITAL**, sound is not output from the analogue AUDIO OUT(L, R) jacks and the speakers on the unit. Any 96kHz Sampling rate digital audio will be output through the analogue outputs only, not the digital outputs.
- MPEG Audio will be output with 2 channel digital audio when you set to **DIGITAL**.
- DTS Audio will be output to COAXIAL or OPTICAL even if you set to **ANALOGUE**.

Language code list

Enter the appropriate code number for the initial settings "AUDIO", "SUBTITLE" and/or "MENU LANGUAGE" (see pages 39, 40 and 43).

Language Name	Code	Language Name	Code	Language Name	Code	Language Name	Code
Abkhazian	1112	Fiji	1620	Lingala	2224	Singhalese	2919
Afar	1111	Finnish	1619	Lithuanian	2230	Slovak	2921
Afrikaans	1116	French	1628	Macedonian	2321	Slovenian	2922
Albanian	2927	Frisian	1635	Malagasy	2317	Somali	2925
Ameharic	1123	Galician	1722	Malay	2329	Spanish	1529
Arabic	1128	Georgian	2111	Malayalam	2322	Sundanese	2931
Armenian	1835	German	1415	Maltese	2330	Swahili	2933
Assamese	1129	Greek	1522	Maori	2319	Swedish	2932
Aymara	1135	Greenlandic	2122	Marathi	2328	Tagalog	3022
Azerbaijani	1136	Guarani	1724	Moldavian	2325	Tajik	3017
Bashkir	1211	Gujarati	1731	Mongolian	2324	Tamil	3011
Basque	1531	Hausa	1811	Nauru	2411	Tatar	3030
Bengali; Bangla	1224	Hebrew	1933	Nepali	2415	Telugu	3015
Bhutani	1436	Hindi	1819	Norwegian	2425	Thai	3018
Bihari	1218	Hungarian	1831	Oriya	2528	Tibetan	1225
Breton	1228	Icelandic	1929	Panjabi	2611	Tigrinya	3019
Bulgarian	1217	Indonesian	1924	Pashto, Pushto	2629	Tonga	3025
Burmese	2335	Interlingua	1911	Persian	1611	Turkish	3028
Byelorussian	1215	Irish	1711	Polish	2622	Turkmen	3021
Cambodian	2123	Italian	1930	Portuguese	2630	Twi	3033
Catalan	1311	Japanese	2011	Quechua	2731	Ukrainian	3121
Chinese	3618	Javanese	2033	Rhaeto-Romance	2823	Urdu	3128
Corsican	1325	Kannada	2124	Romanian	2825	Uzbek	3136
Croatian	1828	Kashmiri	2129	Russian	2831	Vietnamese	3219
Czech	1329	Kazakh	2121	Samoan	2923	Volapük	3225
Danish	1411	Kirghiz	2135	Sanskrit	2911	Welsh	1335
Dutch	2422	Korean	2125	Scots Gaelic	1714	Wolof	3325
English	1524	Kurdish	2131	Serbian	2928	Xhosa	3418
Esperanto	1525	Laothian	2225	Serbo-Croatian	2918	Yiddish	2019
Estonian	1530	Latin	2211	Shona	2924	Yoruba	3525
Faroese	1625	Latvian, Lettish	2232	Sindhi	2914	Zulu	3631

Connections to other equipments

The exact arrangement you use to interconnect various video and audio components to the TV/DVD is dependent on the model and features of each component. Check the Owner's Manual provided with each component for the location of video and audio inputs and outputs.

Using an Audio Amplifier

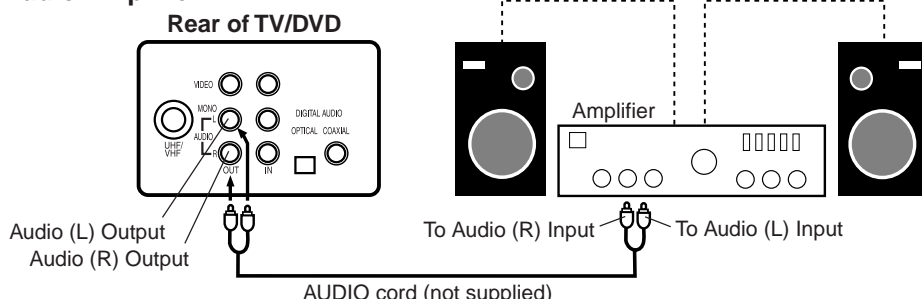

Using an AV Amplifier with built-in digital surround

If you are using an Amplifier with a built-in digital surround as follows, you can enjoy the various audio systems including Dolby Digital Surround audio that sounds just like the movie.

Connect an AV amplifier with built-in Dolby Digital decoder, DTS decoder, MPEG decoder or etc as shown below.

- Set the AUDIO OUTPUT to DIGITAL in the SETUP mode. (See page 44.)

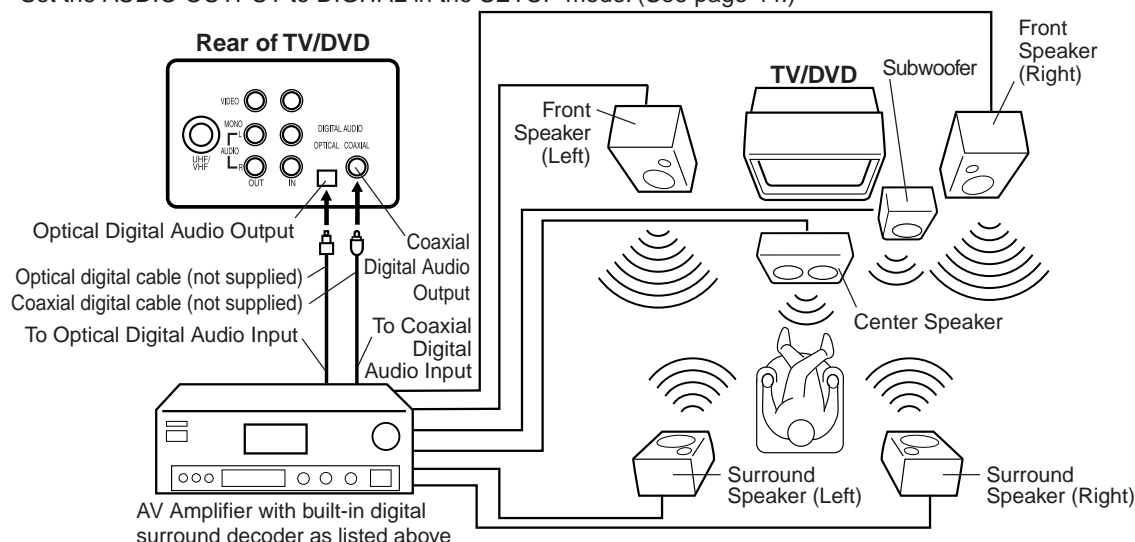

* Manufactured under license from Dolby Laboratories. "Dolby" and the double-D symbol are trademarks of Dolby Laboratories. Confidential unpublished works. © 1992-1997 Dolby Laboratories, Inc. All rights reserved.

* DTS and DTS Digital Out are trademarks of Digital Theater Systems, Inc.

Connecting the optical digital cable

- When you connect the optical digital cable (not supplied), remove the dust protection cap from the rear of DVD.
- When not using the optical digital cable, attach the dust protection cap to protect against dust.

NOTE:

- When you make the connections above, do not set DOLBY DIGITAL to DOLBY DIGITAL, MPEG to MPEG to ON on the AV Amplifier. If you do, a loud noise will suddenly come out from the speakers, affecting your ears or causing the speakers to be damaged.
- Caution for the **optical** digital audio output connector: Do not connect to an amplifier (with an optical digital input connector) which does not contain a Dolby Digital or MPEG decoder. Otherwise, any attempt to play DVDs may cause such a high level of noise that it may be harmful to your ears and damage your speakers.
- When you make the connections above, do not set DOLBY DIGITAL to DOLBY DIGITAL, MPEG to MPEG or DTS to ON on the AV Amplifier. If you do, a loud noise will suddenly come out from the speakers, affecting your ears or causing the speakers to be damaged.
- Caution for the **optical** digital audio output connector: Do not connect to an amplifier (with an optical digital input connector) which does not contain a Dolby Digital, DTS or MPEG decoder. Otherwise, any attempt to play DVDs may cause such a high level of noise that it may be harmful to your ears and damage your speakers.
- Some DTS decoders which do not support DVD-DTS interface may not work properly with the unit.

TV/DVD/AV SELECTION

If you connect the TV/DVD to VCR, camcorder or TV game, you can select by pressing the TV/DVD/AV button.

Press the TV/DVD/AV button repeatedly to select the desired mode.

"DVD", "AUX1" or "AUX2" will display on the screen for 4 seconds.



NOTE:

When the unit is in DVD or AV mode, and with no signal input to the unit through AV jack, the TV screen shows completely dark as if the unit is powered off. Make sure to turn off the unit, unless you want to enjoy DVD playback.

1. To connect the TV/DVD to a VCR

Press the TV/DVD/AV selector button to select the AV mode to use the TV as a monitor.

Operate your VCR as usual.

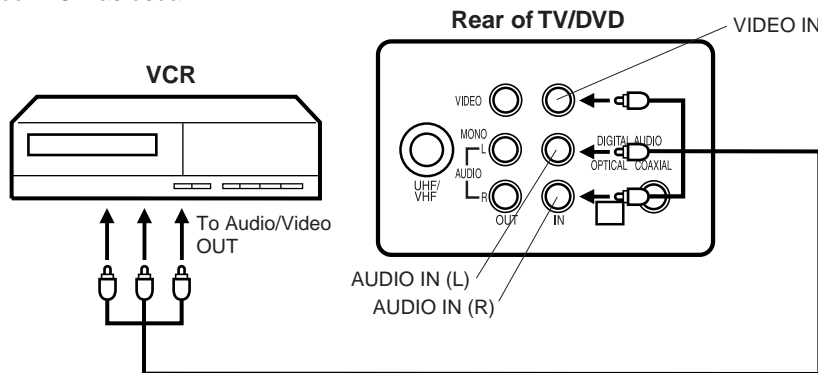

2. To connect the TV to a TV Game

The TV/DVD can also be used as a display device for many video games. However, due to the wide variety of different types of signal generated by these devices and subsequent hook-up variations required, they have not all been included in the suggested connection diagrams. You'll need to consult each component's Owner's Manual for additional information.

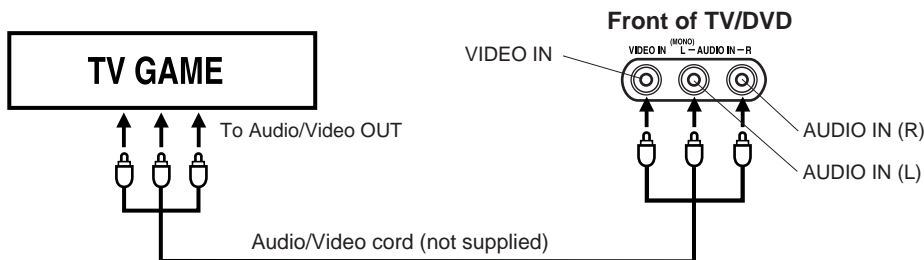

3. To connect the TV to a camcorder

To playback from the camcorder, connect the camcorder to the TV/DVD as shown.

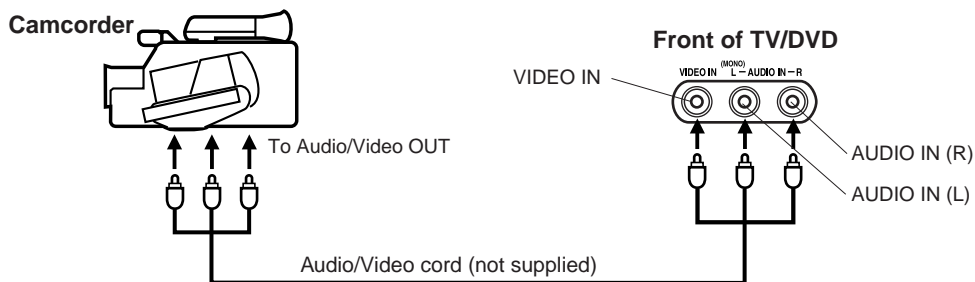

Problems and troubleshooting

Use the following check list for troubleshooting when you have problems with your unit. Consult your local dealer or service outlet if problems persist.

Be sure all connections are properly made when using with other units.

SYMPTOMS	POSSIBLE SOLUTIONS	PAGE
POWER		
TV/DVD does not operate	<ul style="list-style-type: none"> • Make sure the power cord is plugged in. • Try another AC outlet. • Power is off, check fuse or circuit breaker. • Unplug unit for an hour, then plug it back in. 	11
TV BROADCAST RECEPTION		
Poor sound or No sound	<ul style="list-style-type: none"> • Station or CATV experiencing problems, tune to another station. • Check sound adjustments (Volume and Muting). • Check for sources of possible interference. 	15 16 50
Poor picture or No picture	<ul style="list-style-type: none"> • Station or CATV experiencing problems, tune to another station. • Check antenna or CATV connections, reorient antenna. • Check for sources of possible interference. • Check picture control adjustments. 	15 12,13 50 23
Poor reception on some channels	<ul style="list-style-type: none"> • Station or CATV experiencing problems, tune to another station. • Station signal is weak, reorient antenna to receive weaker station. • Check for sources of possible interference. 	15 12,13 50
Poor color or no color	<ul style="list-style-type: none"> • Station or CATV experiencing problems, tune to another station. • Make sure channels are set into memory. • Check picture control adjustments. • Check antenna or CATV connections, reorient antenna. • Check for sources of possible interference. 	15 19 23 12,13 50
Picture wobbles or drifts	<ul style="list-style-type: none"> • Station or CATV experiencing problems, tune to another station. • Make sure channels are set into memory. • CATV company is scrambling signal. • Check antenna orientation. 	15 19 – 12,13
No CATV reception	<ul style="list-style-type: none"> • Check all CATV connections. • Set TV/CATV menu option to the CATV mode. • Station or CATV system problems, try another station. 	12-13 18 15
Horizontal or diagonal bars on screen	<ul style="list-style-type: none"> • Check antenna connections, reorient antenna. • Check for sources of possible interference. 	12,13 50
No reception above channel 13	<ul style="list-style-type: none"> • Make sure TV/CATV menu option is in the appropriate mode. • If using antenna, check UHF antenna connections. 	18 12
TV shuts off	<ul style="list-style-type: none"> • No broadcast on station tuned. • Sleep Timer is set. • Power interrupted. 	19 16 –
Closed - Caption is not activated.	<ul style="list-style-type: none"> • TV station experiencing problems or program tuned is not closed captioned. Try another channel. • Check CATV connection or VHF/UHF antenna, reposition or rotate antenna. • Press TV/CAPTION/TEXT button to turn on the closed caption decoder. 	19 12,13 17
Display is not shown in your language.	<ul style="list-style-type: none"> • Select proper language in the menu options. 	14

SYMPTOMS	POSSIBLE SOLUTIONS	PAGE
DVD		
Playback doesn't start.	• No disc is inserted.	28
	• The disc may be dirty. Clean up the disc.	26
	• The unit cannot play CD-ROMs, etc.	–
No picture	• TV/DVD/AV selector is not set correctly.	27
No sound	• Check the input selector of the amplifier is set properly.	–
	• The unit is in the Special playback mode.	29
	• Select AUDIO OUTPUT to ANALOGUE.	44
Picture is distorted during CUE or REVIEW.	• The picture will be distorted occasionally.	–
Stopping playback, search, slow-motion play, repeat play, or program play, etc. cannot be performed.	• Some discs may not do some of the functions.	–
No 4:3 (16:9) picture	• The setup does not match your TV.	41
No on-screen display	• Select OSD DISPLAY ON.	42
No surround sound	• The setup does not match your stereo system.	44
The unit or remote operation key is not functioning.	• Turn off the unit and unplug the AC power cord for several minutes, then replug it.	–
Playback does not start when the title is selected.	• Check the RATING LEVEL setup.	38
Audio soundtrack and/or subtitle language is not changed when you play back a DVD.	• Multilingual language is not recorded on the DVD disc.	39,40
No subtitle	• Some discs have no subtitles.	40
	• Subtitles are cleared. Press SUB TITLE.	
Angle cannot be changed.	• Multi-angles are not recorded on the DVD disc.	36
"!" is appears on the screen.	• The function is prohibited with the unit.	–
"!!" is appears on the screen.	• The function is prohibited with the disc.	–
REMOTE CONTROL		
The remote control does not function.	<ul style="list-style-type: none"> • Aim at the remote control at the remote sensor. • Operate within Approx. 5 Meters or reduce the light in the room. • Clear the path of the beam. • The batteries are weak. Replace the batteries. • Check the batteries are inserted correctly. 	11



FOR ADDITIONAL SET-UP INFORMATION OR CUSTOMER SERVICE
PLEASE CALL:
1-800-919-3647

Reception disturbances

Most types of television interference can be remedied by adjusting the height and position of the VHF/UHF antenna. Outdoor antennas are recommended for best results. The most common types of television interference are shown below. If one of these symptoms appear when the TV/DVD is connected to a Cable TV system, the disturbance may be caused by the local Cable TV company broadcast.

IGNITION

Black spots or horizontal streaks may appear, the picture may flutter or drift. Usually caused by interference from automobile ignition systems, neon lamps or AC powered tools and appliances such as drills or hair dryers.



GHOSTS

Ghosts are caused by the television signal following two paths. One is the direct path and the other is reflected by tall buildings, hills or other large objects. Changing the direction or position of the antenna may improve the reception.



SNOW

If the TV/VCR is located far from the TV station, in a fringe reception area where the signal is weak, small dots may appear in the picture. If the signal is extremely weak, the installation of a larger external antenna may be necessary.



RADIO FREQUENCY INTERFERENCE (RFI)

Caused by two-way radios, this type of interference produces moving ripples or diagonal streaks in the picture. Some cases may cause a loss of contrast in the picture. Changing the direction and position of the antenna or installing an RFI filter may improve the picture.

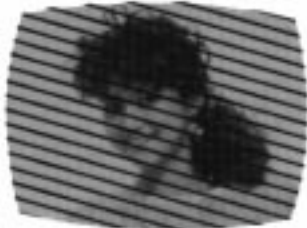

PICTURE SIZE VARIATION

A slight picture size variation is normal when you adjust the CONTRAST or BRIGHTNESS settings.



CARE AND MAINTENANCE

To prevent fire or shock hazard, disconnect the TV/DVD from the power source before cleaning. The finish on the cabinet may be cleaned with mild soap and a soft, damp cloth and cared for as other furniture. Use caution when cleaning or wiping the plastic parts.

Specifications

GENERAL

Power supply:	AC 120V 60Hz
Power consumption:	Operation: 130W Stand by: 8W
Weight:	66.2lbs
Dimensions:	24-5/16" (W) X 23-13/16" (H) 19-1/2" (D)
Operating temperature:	5° - 40°C
Operating humidity:	Less than 80%

TELEVISION

Picture tube:	25" (measured diagonally)
Tuner type:	Quartz PLL Frequency Synthesized
Receiving channels:	VHF 2-13 UHF 14-69 CATV 14-36 (A)-(W) 37-59 (AA)-(WW) 60-85 (AAA)-(ZZZ) 86-94 (86)-(94) 95-99 (A-5)-(A-1) 100-125 (100)-(125) 01 (5A)
Antenna input:	VHF/UHF In 75 ohm coaxial
Speaker:	3", 8 ohm
Audio output power:	2.5W + 2.5W

DVD/CD player

Signal system:	NTSC/PAL
Applicable disc:	1. DVD (12cm, 8cm) 2. CD (12cm, 8cm)
Audio characteristics	
Frequency response:	DVD: 4Hz - 22KHz CD: 4Hz - 20KHz
S/N Ratio:	90dB
Harmonic distortion:	0.01%
Wow and flutter:	Below Measurable Level
Dynamic range:	96dB
Video out:	RCA jack 1.0Vp-p 75ohms, sync negative
Audio out:	RCA jack (L, R) 2Vrms/10Kohm
Digital audio out:	Optical jack: -18dB Wave length: 660nm Coaxial jack: 0.5Vp-p 75ohms terminated
Pickup:	CD: Wavelength: 775 - 815 nm Maximum output power: 0.5 mW DVD: Wavelength: 650 - 666 nm Maximum output power: 2.0 mW

ACCESSORY:	Remote control x 1
-------------------	--------------------

